

ACCA P3 EBOOK DEC 2013

TABLE OF CONTENTS

Note: click the cross-reference below for easy navigation. Click  or press Ctrl + Home to come back.

TABLE OF CONTENTS.....	1
KEY TERMS.....	3
INTENDED BENEFITS OF THE E-BOOK.....	8
AUTHOR'S PROFILE.....	22
IMPORTANT!.....	23
USER'S GUIDE.....	25
INTRODUCTION TO P3 BUSINESS ANALYSIS.....	27
EXAMINER'S GUIDANCE.....	30
AUTHOR'S GUIDANCE.....	35
SOLVING SCENARIO BASED QUESTIONS.....	36
STUDY PLANNER.....	37
PAST PAPER ANALYSIS.....	39
Exam Topic 1: STRATEGIC PLANNING & DEVELOPMENT.....	42
Exam Topic 2: MACRO ENVIRONMENT ANALYSIS.....	52
Exam Topic 3: E-BUSINESS & MARKETING.....	78
Exam Topic 4: MANAGING STRATEGIC PORTFOLIO.....	108
Exam Topic 5: STRATEGIC CHOICE.....	111
Exam Topic 6: MANAGING PEOPLE & ORGANIZATIONAL STRUCTURE... ..	114
Exam Topic 7: STRATEGIC ACTION & MANAGING CHANGE.....	118
Exam Topic 8: BUSINESS PROCESS CHANGE.....	122
Exam Topic 9: PROJECT MANAGEMENT.....	127
Exam Topic 10: FINANCE.....	131

Buy Full ACCA P3 Study Text Book (250±) at ACCASUPPORT.COM | [FB GROUP](#) | [COMMENT](#) | [FORUMS](#) | [JOBS](#)
ACCA F2, F5, F9, PI Study Materials Free Download & ACCA Distance Learning Course & Classes in Karachi



RELATED PRODUCTS..... 135
REPORT ABUSE 136

ACCA STUDY TEXT BOOKS FREE DOWNLOAD

Special Offer

Place a <http://accasupport.com> link at any ONE of your    or other account to get any TWO chapters above of your choice for free not included in free version by emailing at kabuli_52@hotmail.com or murtaza@accasupport.com

Email should contain web page URL where you have placed a link and name of any TWO chapters you want.

KEY TERMS

5 Rights.....	36, 75, 100	Business To Business (B2B).....	92
6 I's	36, 75, 96	Business to Customer (B2C)	92
7Ps.....	36, 75, 77	Capability	116
9Ms	37, 111, 112	Captive Product Pricing	84
Acceptability	110	Cash Cow	107
Acid Test Ratio	129	Coefficient Of Correlation.....	130
Acquisition or Merger	106	Coefficient of Determination.....	131
Adaptation	116	Competency Frameworks	113
After Sales Service	120	Competitive Pricing.....	86
Alien Businesses	106	Control Systems	117
Ansoff's Matrix	106	Corporate Level.....	110
Apollo.....	117	Corporate Parenting.....	106
Ashridge Portfolio Matrix	106	Cost Benefit Analysis.....	125
Athena.....	117	Cost Leadership.....	109
Balance Score Card.....	113	Critical Success Factors (CSF)	113
Ballast Businesses	106	Cultural Web Paradigm.....	117
BCG.....	36, 105, 107	Current Asset Ratio	129
Benefits Realisation.....	126	Customer Satisfaction Perspective ..113	
Big bang change.....	116	Customer to Business (C2B)	92
Bluetooth	90	Customer To Customer (C2C).....	92
Boston Consulting Group (BCG) Matrix	107	Cyclical Variations.....	131
Budget.....	40	Decline.....	107
Bundle Product Pricing	85	Design or Development.....	107
Business Analyst.....	112	Design Requirements.....	123
Business Case	125	Differentiation.....	109, 110
Business Level	110	Dionysus	118
Business Process Improvement	121	Discounted Payback Period	130
Business Process Redesign.....	121	Discounted-Pricing	82
Business Process Re-Engineering... 121		Diversification	107
		Diversity	117

Buy Full ACCA P3 Study Text Book (250±) at ACCASUPPORT.COM | [FB GROUP](#) | [COMMENT](#) | [FORUMS](#) | [JOBS](#)
 ACCA F2, F5, F9, PI Study Materials Free Download & ACCA Distance Learning Course & Classes in Karachi



THIS MATERIAL IS NOT AVAILABLE OFFLINE IN ANY FORM & ONLINE EXCEPT ACCASUPPORT.COM

Dividend Cover.....	130	Gross Profit Margin.....	129
Dividends Yield	130	Growth.....	107
Divisional Structures.....	112	Heartland Businesses.....	106
Dog.....	107	Human Resource.....	120
Downstream Supply Chain.....	120	Hybrid Strategy.....	110
Earnings per Share (EPS)	129	Inbound Logistics.....	120
Earnings Yield	129	Incremental change.....	116
E-Business	87	Independence of Location.....	98
E-Commerce	36, 75, 87	Individualism	97
EDI	36, 75, 102	Industry Restructuring	97
Entrepreneurial Structure.....	112	Information System Software.....	89
Evolution	116	Innovation & Learning Perspective	113
External Benchmarking	126	Integration.....	97
External Growth	106	Intelligence.....	96
Failure Strategies.....	110	Interactivity	96
Feasibility	110	Interest Cover.....	129
Financial Benefits.....	126	Internal Business Perspective.....	113
Financial Gearing	129	Internal Development.....	106
Financial Perspective.....	113	Internet.....	102
Firm Infrastructure	120	Introduction	107
Flexibility.....	121	Inventory Turnover	129
Focus.....	109	Japanese Management.....	114
Focus-Differentiation	110	Job Enlargement	114
Focused- Differentiation	109	Job Enrichment.....	114
Forward Auction.....	93	Job Rotation	114
Franchise	106	Key Performance Indicators (KPI)	113
Full Cost Plus Pricing	85	Low Price.....	110
Functional Requirements.....	122	Machine Bureaucracy.....	112
Functional Structures.....	112	Machinery.....	112
Gaps & Disconnects.....	121	Make Up	113
Generic Strategies	109	Management.....	113
Goal	36, 39, 40	Management Information.....	113

Buy Full ACCA P3 Study Text Book (250±) at ACCASUPPORT.COM | [FB GROUP](#) | [COMMENT](#) | [FORUMS](#) | [JOBS](#)
 ACCA F2, F5, F9, PI Study Materials Free Download & ACCA Distance Learning Course & Classes in Karachi



Marginal Cost Plus Pricing.....	86	Outsourcing	37, 119, 121
Marketing	76	Oversees Acquisition.....	106
Marketing & Sales	120	Parental Developer.....	106
Marketing Mix (7 Ps).....	77	Paul Harmon’s Process Strategy Matrix.....	122
Markets.....	113	Payout Ratio.....	130
Materials.....	112	People.....	81
Matrix Structure.....	112	Person Culture.....	118
Maturity.....	107	PESTEL Analysis.....	50
Measureable Benefits	126	Physical Evidence.....	80
Mendelow matrix	71	Pilot Operations	126
Methods.....	113	Place	79
Michael Porter’s Diamond Model.....	65	Portfolio Manager	106
Michael Porter’s Five Forces Model.....	58	Position Based Strategies.....	110
Michael Porter’s Value Chain Analysis	120	Post Implementation Review.....	126
Mission	36, 39, 40	Power.....	116
Modelling & Simulation	126	Power Culture.....	117
Modem.....	89	Premium Pricing	83
Money.....	112	Preservation	117
Nature of Change.....	116	Price.....	78
No Frills Strategy.....	110	Price Earnings (P/E) Ratio	129
No-Frills Pricing.....	81	Price Penetration.....	82
Non Functional Requirements.....	122	Price Segmentation	84
Objective	36, 39, 40	Price Skimming	83
Operating Profit Margin.....	129	Primary Activities (Core Activities)	120
Operational Gearing.....	129	Problem Child	107
Operational Level.....	110	Process.....	80
Operations	120	Procurement.....	120
Optional Product Pricing	84	Product	78
Organization Structure.....	117	Product Life Cycle	107
Outbound Logistics	120	Product Line Pricing	86
Outline Planning	125	Profitability ratios	129

Project.....	37, 124, 125	SAF	37, 108, 110
Project Charter	37, 124, 126	Scientific Management	114
Project Initiation Document	37, 124, 126	Scope	116
Project Management	125	scope of change	116
Promotion.....	79	Seasonal Variations.....	131
Psychological Pricing.....	87	Simplification.....	121
Pull Marketing.....	76	Star	107
Purchasing Mix.....	36, 75, 100	Stories.....	117
Push Marketing	76	Strategic Alliance.....	106
Qualitative Benefits	126	Strategic Capability	112
Quantifiable Benefits.....	126	Strategic Clock.....	109
Question Market.....	107	Strategic Success Criteria ...	37, 108, 110
Quick Ratio	129	Strategy.....	36, 39, 40
Random Variations	131	Suitability	110
Ratio Analysis.....	129	Supply Chain	120
Readiness.....	117	Supporting Activities.....	120
Realignment	116	SWOT Analysis.....	70
Reconstruction	116	Symbols	117
Reengineering	121	Synergy Manager.....	106
Reference Sites	126	System Implementation.....	123
Residual Income (RI).....	130	Task Culture	117
Resource Audit.....	37, 111, 112	Technical Requirements	123
Resources.....	112, 116	Technology Development	120
Return on Capital Employed (ROCE)	130	Time Series Analysis	131
Return on Equity (ROE).....	130	Trade Payable Turnover.....	129
Return on Investment (ROI).....	130	Trade Receivable Turnover.....	129
Reverse Auction.....	93	Transformation	116
Revolution	116	Trend	131
Risk Analysis	125	Unrelated Diversification.....	107
Role Culture.....	117	Upstream Supply Chain	120
Routines & Rituals.....	117	Value Added Analysis.....	121
		Value Trap Businesses	106

THIS MATERIAL IS NOT AVAILABLE OFFLINE IN ANY FORM & ONLINE EXCEPT ACCASUPPORT.COM

Web Server Software 89

Zeus 117

FREE

Buy Full ACCA P3 Study Text Book (250±) at ACCASUPPORT.COM | [FB GROUP](#) | [COMMENT](#) | [FORUMS](#) | [JOBS](#)
ACCA F2, F5, F9, PI Study Materials Free Download & ACCA Distance Learning Course & Classes in Karachi



INTENDED BENEFITS OF THE E-BOOK

Features &

Benefits of ACCA Study Text Ebook

1) **Exam Focused:**

Exam focused ACCA study text ebooks are aimed to help you passing exams by allowing you spend **efforts and time smartly**.

ACCA study text books aim to educate you in the way you are **expected to apply** your knowledge in the exam.

ACCA study text books are **updated** prior to each exam session and during the exam session in the light of recent information available such as examiner published an article in student accountant. In that case, you will **receive updated version** of relevant ACCA study text book via e-mail.

accasupport.com

Usually **ACCA** students look for **ACCA exam tips** at the end of exam session to learn important syllabus areas much better. Therefore, those ACCA students usually do exam focused study only 2 weeks or 1 month before. ACCA students can greatly improve the probability of **passing exams** if they do exam focused study from the beginning.

Exam Focused ACCA Study Text Books

bring all relevant information under one roof to eliminate information gathering on relevant ACCA

exam paper and prevents the chances of omission of important information about the relevant ACCA exam paper.

These study materials take account of examiners comments and reports, past exam papers, student accountant articles, tips from other tutors, syllabus areas examined by other professional accountancy bodies, publications in business magazines etc.

2) **Examiner's Guidance:**

Examiner's Guidance are **exam preparation tips** given by the examiner in **student accountant, examiner's interview** and other documents.

3) **Author's Guidance:**

Author's guidance are **applicable to all syllabus areas**.

It also includes tips to enable you to **prepare for exams** and **perform during exams** effectively .

4) **Exam Awareness:**

Exam Awareness shows the **frequency and magnitude** (marks) of each syllabus area.

It also shows the **relationship** between various syllabus areas and how each syllabus area **contributes** toward passing exams.

5) **Exam Support:**

Exam Support provides guidance on **application of knowledge** in exam context.

Just knowledge is not enough for passing exams rather you have to use it wisely in limited time

available in the exams.

6) Past Paper

Analysis (F5, F9, P1, P3):

Past paper analysis is given at the **beginning** of the study text and also **directly below** relevant headings.

Past paper analysis at the beginning of the study text enables you to practice past exam questions relevant to each syllabus area on ACCA global website. Therefore, you **do not need to buy** expensive **practice kit** or search for relevant questions to practice a particular syllabus area.

Past paper analysis directly below each relevant heading gives an **idea** about the length, complexity of requirements and VERBS (Explain, Evaluate, Report etc) in which each syllabus area can be examined.

7) Learning Objective (F2/FMA only):

Learning objective sets the **knowledge and skills expected** to be achieved after reading particular syllabus area.

F2 Management Accounting exam format does not provide significant benefit from past paper analysis. In **CBE (computer based exams)** each candidate may be examined different set of **questions**.

However, importance of each exam topic is discussed under exam awareness and exam support headings.

8) **Illustrations (if any):** Illustrations are **simple numerical examples** given to prepare students for more challenging exam standard questions.

Illustrations depend on the **type of ACCA paper**. Discussion based ACCA papers may not include illustrations.

9) **Explanations (if any):** Explanations are given to explain the **rationale** (why & how) behind steps involved in calculations.

Explanations depend on illustrations provided in the **study text book**.

10) **Examples:** Examples are given to explain technical theoretical knowledge in **simple and understandable way**.

Technical jargons are used to prepare you for different technical terms used by the examiner to dodge you to ensure that you understood the text rather than rote learn the text.

These technical jargons are explained in parenthesis or as separate example to make you understand the technical term and syllabus area as whole.

It also shows the **application of knowledge** into practice.

It is especially useful when you are **expected to apply** your knowledge to answer scenario based

questions.

Processing information meaningfully and logically leads to better retention of information. Linking new information to information already committed to your memory, such as every day experiences, is proven technique for learning new knowledge.

It will also **motivate** you to learn harder, as you will understand the benefits of technical knowledge **in your career** as chartered accountant.

11) **Diagrams:**

Diagrams are given to explain **complex concepts and procedures**, which are difficult to understand in words.

Diagrams also lead to better **memorization** of knowledge.

Diagrams lead to the use of **right brain** while text lead to the use of **left brain**. Combination of text and diagrams enables you to learn ACCA papers using both brains to avoid getting overstressed left part of the brain due to excessive reading.

Left brain is responsible for reading, calculation, analysis. Right brain is responsible for establishing relationships, reading graphs & charts and dealing with non-financial aspects,

such as motivation of managers and employees.

12) Practice Questions:

Practice questions are **exam standard questions** to provide a clue about length complexity and format of questions likely to be asked in the exams.



Solutions are given in a format that will **save time**, while solving questions during the exams.

Time management is important during exam, ability to solve question but taking more than time available is of no use. You must be able to solve question within given time. Therefore, you must identify, which steps will be rewarded and which steps can be omitted without losing marks.

In addition, your solution should be properly cross-referenced such as working 1, 2, 3 etc and labelled using descriptive text rather than abbreviations.

Solution is supported with explanations to tell you why and how that particular step is performed.

13) Hyperlinks:

Hyperlinks are **links** to other areas of study text book. In addition, **table of exam topics** are linked  to **exam topics** and **table of sub exam topics** are linked  to **sub exam topics** given at the beginning of each exam topic.

Hyperlinks will save several minutes per day, which you may spend navigating through ordinary printed and ebooks. Hyperlinks will save large amount of time during the whole exam session.

14) Bookmarks:

Bookmarks are given for reaching quickly to relevant **syllabus area**. It is an alternative to hyperlinks.

15) Key Terms:

Table of key terms shows **important terms** across the study text book that you must understand in order to learn relevant topic and pass the exams.

It allows you to reach to the place inside study text book, where you can develop **basic understanding** about particular term.

16) Colours:

Colours are used for **demarcation** between essential text, supporting examples, exam support etc.

It will enable you to **find** required ebook feature such as example, exam support, diagram etc easily.

It also make learning **interesting**. Writing golden words without motivating reader to read it is of little use.

17) Annotations:

You can highlight text and add comment anywhere in the study text book.

Highlighting will enable you to **highlight phrases** and sentences you want to read again.

Commenting will allow you to make a **brief note** in the study text book. You can use commenting to:

- **Save** mnemonics.
- **Mark** as read important, unread, read, Revised etc.

However, most publishers do not allow these features to enforce their copyrights.

18) Readout Loud:

Readout load enables students to **listen** written text. You can use any screen reader of your choice to convert text to speech.

Those who have **problem reading text** can particularly benefit from this feature.

Others can have a **break from reading** text.

Listening involves the use of Right brain opposed reading, which involves the use of Left brain.

Listening allows your Left brain to revitalize for future reading.

It will also help **revision** of your syllabus before exams much faster. It is usually believed that listening is many times faster process than reading. You can adjust the speed according to

your preference.

Each point of theory is started from separate line to enable you to listen only the **text of your interest**.

19) **Accessibility:**

These study text books have **legible fonts type & size and high contrast** colours to enable you read easily without producing strain on your eyes.

You do not need to zoom and then scroll horizontally  to read study text.

You can switch to two pages per screen layout to avoid frequent vertical scrolling, without compromising readability to significant extent.

20) **Study Planner:**

Study planner is a method allows you to **plan for study** within limited time available.

It also allows you to **track your progress** against plan; therefore, you can adjust your speed of study and study hours accordingly.

Time management is specially important for professional students that you have to meet other commitment such as job, friends and family.

21) **Printer Friendly:**

ACCA study text books are **economical** to print.

Diagrams, tables and other formatting are made to keep the cost of printing to minimum.

You may consider printing two pages side by side to save papers and cost, without compromising readability to significant extent.

Most other publishers do not allow printing an ebook at all or just allow to printed 25% - 60% of the ebook pages. accasupport.com allows 100% printing of the ebook pages.

It will also provide **portability** as you can easily carry it in our bags.

22) PDF File Format: PDF (Portable document format) files can be viewed using **free adobe reader**.

Adobe reader is compatible with most operating systems such as **windows, Mac, Android etc.**

You can also read ACCA study text ebook on **tablets and cell phones** supporting PDF format to take these ebooks **on the way or at workplace** in your pocket.

Therefore, you also **do not need** to buy pocket notes too.

It can be used on multiple computers and mobile device without any limitation imposed on the number of devices.

PDF file format is widely used file format used to compress file size of electronic documents such as ebooks and takes very little time to load as compare to ebooks having EXE file format.

ACCA study text ebook is searchable through any

software having find and replace function.

However, conversion of PDF into **DOC, TXT** etc format may distort structure of an ebook or make it unreadable at all.

23) **Environment Friendly:**

Reading Ebooks on digital media such as **PC, laptop, tablets, cell phones** are among the best ways to save papers and therefore, environment from greenhouse effect.

Millions of papers can **save thousands of trees each day.**

It also prevents **CO₂ emission** in traveling or delivery of printed books in addition to traveling or delivery cost and time.

In addition, it is our **moral duty to care** for environment and society who lives in that environment.

24) **Instant Download:**

You can benefit from **studying immediately** after download. Step-by-step guidance is given for downloading ebook for first time buyers.

One step secured order form without any registration. All major credit cards & paypal accepted.

No installation required of custom software design to enforce copyrights. Custom software may not work well with different PCs, laptops, mobile devices etc, as it is virtually impossible to test custom software against different hardware and software specifications.

Some anti-virus softwares prevent unpopular

softwares from running on the system. Therefore, you may need to disable anti-virus prior to executing the application.

PDF file format is widely used file format for sharing documents online and offline. Therefore, it is very unlikely to have issues with PDF file. There are numerous free PDF readers available to suit your needs.

No licensing and online registration requirements.

No waiting time for receiving password or ebook itself.

Please! Note that ebook cannot be refunded due to instant download and no DRM (Digital Rights Management) protection software imposed, as others.

25) **Guaranteed Pass:**
(nothing to lose)

You will be granted 100% **free study text ebook** for subsequent exam session until you pass your exams.

Unfortunately, if an **ACCA student** does not make a pass, then he/she has to send an e-mail along with **ACCA result** screen shot/**PDF** file and customer order number or transaction identification number.

26) **Harmony**

Most publishers do not involved writing and editing their books. They hire writers having expert knowledge on particular topic. However, they are not connected with ACCA training provision and therefore, not aware of practical challenges, jargons etc faced by students during the exams and areas of weakness on the part of students.

It creates lack of harmony between different

syllabus areas. Each syllabus area seems to be unrelated to each other while studying. However, most examiners require students to demonstrate the understanding of overlapping nature of the syllabus. This would not be a case, if entire syllabus of relevant ebook was written by one mentor.

27) Core Activity

Many publishers using their study text books as marketing tool for other highly profitable activities such as tuition providing, recruitment agency, paid advertising etc. Ebook publishing is not their core competency. They tend to direct their resources towards more profitable activities, while quality of ebooks may suffer as a result.

accasupport.com is devoted full time to ebook publishing and continuously acquire new skills (memory techniques, for example) and resources (word processing software, for example) to compile an ebook to support students in much better way.

28) Direct Access

You will have direct access to author & administrator, without having to wait for information to be transfer to and from more than one desk to reach the person responsible for making decision. It will result in quicker response to inquiries. In addition, you need to send only single email to resolve your all issues rather than dealing with different personnel for each issue, regarding purchasing and usage of ebooks.

29) No Hidden Policies

Many publishers provide money back guarantees and gifts etc. However, it is subject to hidden charges and conditions, which are not communicated on sales page and ebook description page. Instead, such policies are communicated on FAQs, Terms of Service, Delivery etc pages.

accasupport.com has no such hidden polices. Refund policy is communicated at the bottom of

home page and instant download feature.

FREE

AUTHOR'S PROFILE

Name: Murtaza Lanewala

Career Status:

Freelance writer & tutor for professional accountancy qualifications. Professional bodies include ACCA, CIMA and ICAEW.

Author & CEO of accasupport.com

E-mail:

kabuli_52@hotmail.com or
murtaza@accasupport.com



IMPORTANT!

1 Disclaimer

This study material is sold only through accasupport.com website. However, Clickbank.com is the credit card processing organization for collecting payments for this study material. This study material **is not available offline (shops, schools etc.)** in any form such as DVDs, CDs, Printed books etc. Study materials purchased from unauthorized source can be out of date and incomplete. In addition, you will not be able to receive **free updates** given to the buyers of original material.

Demo version of this material is available free of cost, please take care, not to pay for demo version of this e-book to unauthorized sellers.

This material is for ACCA examination **Dec 2013 only**. Students who are reading out-dated material are at risk, as it will not be representative of current examination format, terminologies and syllabus.

Readers of this material will be solely responsible for the consequences of any decisions made in real life. Author & accasupport.com are not responsible to the readers of this material under any circumstances.

Recommendations made of any kind are intelligent guesses to the best of author's knowledge.

2 Copyright Notice

This material is subject to copyright protection law. Infringement of copyright law results in criminal liability (fine or imprisonment or both).

Copyright infringement is effectively theft of intellectual property; therefore, it is unethical from social viewpoint and sinful act from religious viewpoint as well.

Copyright ©2012 Murtaza Lanewala. All rights reserved.

2.1 Do

You can make a backup copy of this material.

You can use parts of this material provided you quote the appropriate reference to the author and material.

2.2 Do Not

You cannot publicly share this material in the form of hard copy or soft copy (physically and over the internet) for cash or for free.

You cannot transform this material into other means of communication such as photocopy, video, audio etc. Unless needed for accessibility purpose or personal use.



You cannot change the file format of this material or make it editable.

You cannot resell this material unless you are selling the original copy purchased.

You cannot use any part of this material in or with contents associated with violence, politics, religious and pornographic contents in any way.

[Earn](#)

USER'S GUIDE

E book features	Details
Past papers	Past papers provide a clue about the verbs (Explain, Evaluate etc.) and marks available in the exams.
Sub Exam Topics	It provides list of main headings at the beginning of each exam topic. You have to click relevant heading in a list to reach there.
Exam Topic Awareness	It provides broad information on composition (theoretical v computational) and importance of each paper in exam context.
Exam Support	Exam Support provides detailed information on application of theory and calculations in exam context.
Example	Example provides practical application of technical theoretical knowledge.
Illustration (if any)	Illustration provides numerical applications of theoretical knowledge.
Explanation (if any)	Explanation provides the reasons for correctness or un correctness of particular statements and calculation.
Formula (if any)	Formula is mathematical equation or tabular format.
Diagram	Diagrams are visual (Graph, Charts, Tree formats etc.) presentations of theoretical knowledge.
Cross reference	Cross-referencing are hyperlinks to other exam topics. Click previous view button   to go back or ALT + Left Arrow key.
Highlighting	Highlighting is used show the relationship between words and figures.
Bookmarks 	Click bookmark icon in the side bar (see below) to jump to specific exam topic in the e-book.

Screen Shot:

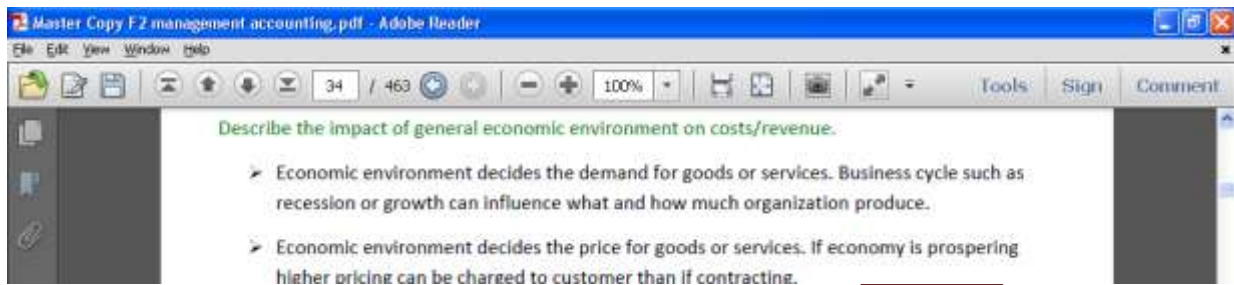

If you not currently using adobe reader, then I recommend you to download adobe reader, to get most benefits from this e-book. Click <http://get.adobe.com/reader/> to download.

INTRODUCTION TO P3 BUSINESS ANALYSIS

1 Examiner

Steve Skidmore is examiner for Paper P3.

2 Aim

To apply relevant knowledge, skills and exercise professional judgement in assessing strategic position, determining strategic choice, and implementing strategic action through beneficial business process and structural change; coordinating knowledge systems and information technology and by effectively managing processes, projects, and people within financial and other resource constraints.

3 Assumed Knowledge from Previous Papers

You are expected to have knowledge from following papers for the purpose of this exam.

F1 Accountant in Business

F7 Financial Reporting.

4 Position of P3 Business Analysis in ACCA

Diagram:

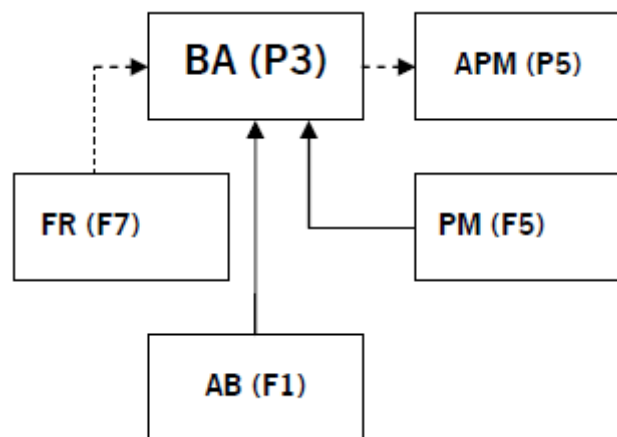

Exam Support:

Syllabus areas that are not included in the study guide of previous papers are more likely to be examined in P3 Business Analysis than those that are already included in previous papers.

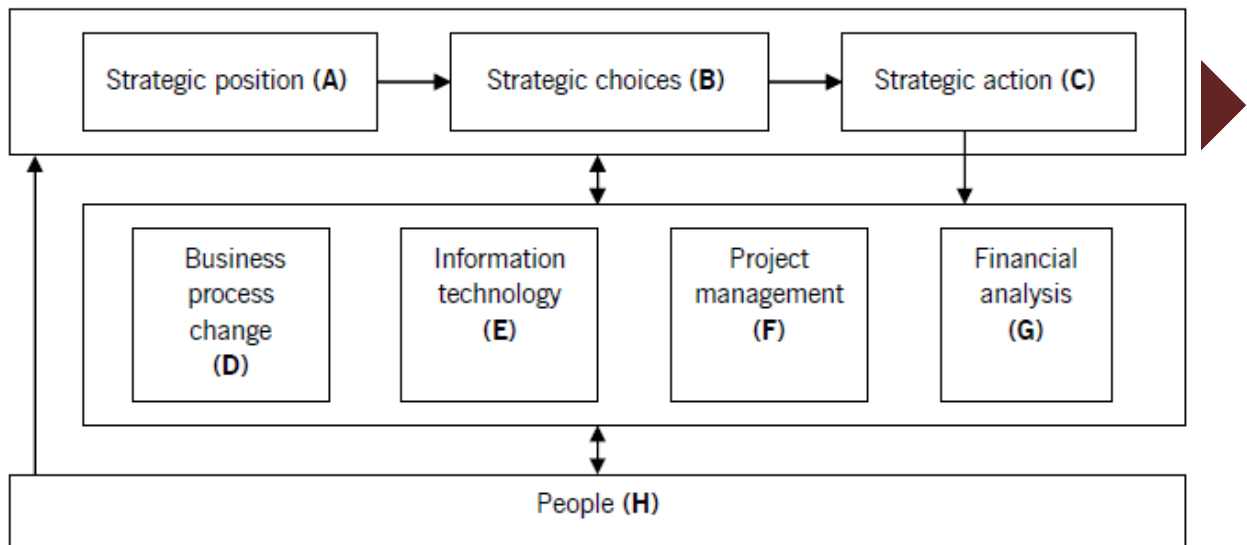
5 Main Capabilities & Relationships**Diagram:****6 Exam Paper Format**

Section A contains 1 compulsory question for 50 marks, inclusive of 4 professional marks for rewarding communication and presentation skills.

Section B contains 3 questions for 25 marks, out of which you can choose any 2 questions.

Questions could be comprised of many requirements (a, b, c, d etc) and sub requirements (a(i), a(ii)).

ACCA P3 Business Analysis is around 80% discussion and 20% calculation based paper. However, memorizing text will not help you passing the exam rather you should be able to apply your knowledge to scenario-based questions. Information provided in the scenarios is taken from real world.

7 Duration of Exam

Total time: 3 hours 15 minutes

3 hours are writing and reading time.

Additional 15 minutes are reading and planning time. However, you can annotate question paper only during that time.

8 Resources:

<http://www.accaglobal.com/en/student/qualification-resources/acca-qualification/acca-exams/p3-exams.html>

<http://www.accaglobal.com/en/student/Essentials/pass-exams.html>

<http://updates.accasupport.com>

<http://accasupport.com/blog/>

EXAMINER'S GUIDANCE

by **Steve Skidmore**

26 Jan 2007

- The relational diagram of main capabilities – as illustrated in the *Syllabus* – shows how the various parts of the syllabus for Paper P3, *Business Analysis* are interrelated. Each part of the relational diagram is annotated with the relevant syllabus section. For example, ‘Strategic position [A]’ refers to Section A of the *Syllabus*. Each section of the syllabus is expanded into a detailed syllabus, which is expanded further in the *Study Guide*. The *Syllabus*, *Study Guide*, and *Pilot Paper* can be downloaded from the ACCA website. The reading list is also included in the *Study Guide*.
- **Structure**
The ‘top layer’ of the relational diagram reflects the vocabulary of *Exploring Corporate Strategy*, by G Johnson, K Scholes, and R Whittington, (Prentice Hall 2005, seventh edition) – one of the primary reference texts. The syllabus begins with the assessment of the strategic position of an organisation, before moving on to consider the strategic choices available to it. Finally, strategic action concerns the implementation of strategic choices through appropriate organisational actions. Sections A, B and C of the syllabus generally follow the structure of Johnson, Scholes, and Whittington, and certainly use their vocabulary. Terms such as competencies, capabilities, strategic directions, and strategic methods are used in the *Syllabus* and *Study Guide*, as defined in their book. This ‘top layer’ is closely related to parts of the Paper 3.5 syllabus.
- The ‘middle layer’ is an expansion of the implementation of strategy. Understanding the strategic position of an organisation, and considering the strategic choices open to it, are of little value unless the preferred strategies can be turned into organisational action. Johnson, Scholes, and Whittington acknowledge that ‘such action takes form in the day-to-day procedures and relationships

that exist in organisations.’ Furthermore, strategies may emerge from these day-to-day activities, and the inclusion of this ‘middle layer’ (and indeed the ‘bottom layer’) should give candidates more opportunity to reflect on strategy as an emergent, rather than a designed, activity.

- The focus of the ‘middle layer’ is on process redesign and automation, the e-business application of information technology, and the role of quality – both as a threshold value and a differentiator. It is perceived that these three elements are also interconnected. For example, many process redesign initiatives use information technology to achieve improvements in product or service quality. All three elements require effective project management. Finally, strategic position, choices, and implementation are all subject to financial benchmarks. Financial analysis explicitly recognises this, reminding candidates of the importance of focusing on the key ratios and measures that may be used to assess the position of an organisation, the viability of a selected strategy, and the monitoring and measuring of its success. This builds on capabilities defined in Paper F7, *Financial Reporting* and Paper F9, *Financial Management*.
- The ‘bottom layer’ of the relational diagram recognises that successful strategic planning and implementation requires the effective recruitment, training, motivation, and organisation of people. This section picks up from material covered in Paper F1, *Accountant in Business*. Candidates preparing themselves for the Paper P3 exam should familiarise themselves with the contents of the Paper F1 syllabus – particularly Sections A, B, E, and F.
- **Exam format and Pilot Paper**
The syllabus is assessed by a three-hour exam, which comprises two sections. Section A contains one multi-part question based on a case study scenario. This question is worth 50 marks. Section B will consist of three discrete questions each worth 25 marks. Candidates must answer two questions from this section.
- The case study for Section A of the *Pilot Paper* is based on the case study from the June 2004 Paper 3.5 exam. However, changes have

been made to the text of the case study, and to the questions and model answers. This reflects a slight sharpening of the focus of questions in a paper where the explicitly strategic content of the syllabus has been reduced. The original question paper also contained further questions as part of a 60-mark compulsory question.

- The case study scenario will always concern global industries, which should be familiar to candidates sitting this exam anywhere in the world. These industries are frequently the subject of articles in the business press, and so candidates are encouraged to continually read business supplements to help them prepare for this exam.
- The exam will also include quantitative information, which might include financial data. Two points need to be made here:
- Specific marks will be available for interpreting financial ratios that can be calculated from the financial data. The scope of these ratios is defined in Section H3 of the *Study Guide*. The questions will never ask for specific ratios, but there will always be enough information to calculate and interpret – as far as possible in the context of a case study scenario – several financial ratios. These ratios will have been introduced in the Paper F7, *Financial Reporting* syllabus and the Paper F9, *Financial Management* syllabus.
- Non-financial information will also be provided in tables, and candidates will be expected to use and interpret this information. Such tables will supplement, and to some extent replace, information traditionally given in the narrative scenario. For example, if the scenario concerned competing exam providers, it could also now contain a table with information on fee rates, number of candidates, and pass rates.
- Section B will include three discrete questions, each worth 25 marks. Candidates must answer two questions in this section. At least two of the questions in this section will be based on capabilities defined in Sections D, E, F, G, and I of the syllabus. At most, one question in this section will be based on capabilities

defined in Sections A, B, and C of the syllabus. Capabilities defined in Section H of the syllabus may be used to support questions in this section.

- In the *Pilot Paper*, Question 2 was based on Section B of the syllabus, Question 3 on Section F, and Question 4 on Section E. It is likely that the scenarios for these questions will be longer than those in the current Paper 3.5, to reflect the fact that they are now worth 25 marks each. However, this will be compensated for by shorter scenarios in Question 1, and the introduction of 15 minutes reading time for the exam as a whole.
- One of the features of the Professional level exam papers is the awarding of 'professional marks'. These are marks allocated not for the content of an answer, but for the degree of professionalism with which certain parts of the answer are presented. They will usually be awarded in Section A (the compulsory part of the exam paper) and will total between four and six marks.

It may be, for example, that one requirement asks you to present your answer in the form of, say, a letter, a presentation, a memo, a report, briefing notes, or similar. Some marks may be awarded for the form of the answer in addition to the content of the answer. This might be for the structure, content, style and layout, or the logical flow of arguments in your answer. You should assume that if the question asks for a specific format of answer that some marks may be awarded for an effective presentation of that format.

- **Conclusion**

A considerable amount of documentation has been produced for this paper. Candidates, lecturers, and publishers are encouraged to download and read the *Study Guide*. The links within the syllabus are documented in the relational diagram and should be understood by candidates, and reinforced in teaching. The nine sections of the syllabus are interrelated and this interrelationship is particularly tested in the case study question.

- The *Pilot Paper* is a representative paper. It also demonstrates

how Papers 3.5 and – to some extent – Paper 3.4 can be used by candidates to prepare themselves for the Paper P3, *Business Analysis* exam.

- **Steve Skidmore is examiner for Paper P3**

FREE

AUTHOR'S GUIDANCE

1 Preparing for Exams

1 Exam Day Guidance

Please! Buy Full Version

FREE

SOLVING SCENARIO BASED QUESTIONS

1 Overview

8.1 Overview of Organization

9 Analyzing Requirements

10 Reading Scenario

10.1 Organizational Processes

10.2 Strategic Position or External Environment

10.3 Portfolio Management

10.4 Strategic Choice

10.5 Strategic Implementation & Change

11 Make Recommendations & Justification

*Exam Support:
Please! Buy Full Version*

STUDY PLANNER

Determine number of days available

Formula:

$$\text{Number of days available} = \text{Number of days before exam} - \text{Revision time} - \text{Idle time}$$

Idle time can be incurred due to sickness, computer crash, social events etc. It depends on your daily activities and environment.

I recommend you to make a printed copy to read when computer is not available.

Allocation of number of days available till exams

Formula:

$$\text{* Number of days per exam} = \text{Number of days available} \times \frac{\text{Number of pages}}{\text{Total number of pages}}$$

$$\text{Number of pages per day} = \frac{\text{Number of pages per exam}}{\text{Number of days allocated}}$$

Number of pages will include allowance for solving past paper questions, student accountant articles etc.

Please note that different syllabus areas will take different amount of time. Calculations will take more time than theoretical areas. Therefore, it will give you only rough idea of your progress.

Tracking progress

Formula:

$$\text{Revised no of pages per day} = \frac{\text{Remaining total number of pages}}{\text{Number of days available}}$$

If revised number of page per day is > than originally planned, then you are lagging behind and now you have to do more study per day.

Troubleshooting

Study at time of day when you are fresh. This will enable you to learn more in available time.

Consider skip reading examples, if you understood theory by reading main text.

Study in the end sub exam topics, which is less likely to be examined in your exam session. You can see past paper analysis given below each sub exam topic.

FREE

PAST PAPER ANALYSIS

Exam Topics	P/P	06/12	12/11	06/11	12/10	06/10	12/09	06/09	12/08	06/08	12/07
STRATEGIC PLANNING & DEVELOPMENT											
Organizational Mission, Goal, Objective, Strategy & Budget											
Strategic Planning											
Strategic Lenses											
MACRO ENVIRONMENT ANALYSIS											
PESTEL Analysis											
Michael Porter's Five Forces Model											
Michael Porter's Diamond Model											
SWOT Analysis											
Stakeholder Management Matrix											
Benefits & Limitations of Mendelow Matrix											
Considering Response to Stakeholders											
E-BUSINESS MARKETING											
Marketing											
Push Vs Pull Marketing											
Marketing Mix (7Ps)											
Pricing Strategies											
E-Commerce Vs E-Business											
Infra-Structure for Information Technology											
Stages of E-Business Implementation											
E-Business Models											
Benefits of E-Business											
Characteristics of Internet Marketing (6 I's)											
Benefits of E-Procurement											
Purchasing Mix (5 Rights)											
Application of E-Procurement											
E-Procurement Models											
EDI Vs Internet											
Drivers (Facilitators) & Barriers to E-Business											
MANAGING STRATEGIC PORTFOLIO											
Strategies for Organizational Growth											
Rationale for Corporate Parenting											
Ashridge Portfolio Matrix											
Ansoff's Matrix											
Boston Consulting Group (BCG) Matrix											
Product Life Cycle											
Stages of Product Life Cycle											
Benefits of Product Life Cycle											
STRATEGIC CHOICE											
Generic Strategies											

Exam Topics	P/06/12	12/11	06/11	12/10	06/10	12/09	06/09	12/08	06/08	12/07
Strategic Clock										
Position & Resource Based Strategies										
Strategic Success Criteria (SAF)										
MANAGING PEOPLE & ORGANIZATIONAL STRUCTURE										
Roles of Business Analyst										
Organizational Structures										
Strategic Capability										
Resource Audit (9Ms)										
Competency Frameworks										
Performance Appraisal										
Key Performance Indicator & Critical Success Factor										
Balance Score Card										
Benefits & Limitations of Balance Score Card										
Job Design										
STRATEGIC ACTION & MANAGING CHANGE										
Elements of Strategic Change										
Nature & Scope of Organizational Change										
Organization Cultural Change Management										
Cultural Web Paradigm										
4 Types of Organizational Culture										
BUSINESS PROCESS CHANGE										
Michael Porter's Value Chain Analysis										
Supply Chain										
Up & Down Stream Supply Chain										
Organizational Process Change										
Levels of Business Process Change										
Process Redesign & Strategic Planning										
Benefits & Limitations of Outsourcing Processes										
Paul Harmon's Process Strategy Matrix										
Evaluating New Software Packages										
Selecting Software Package Solution										
PROJECT MANAGEMENT										
Project										
Stages Involved In Project Management										
Role or Responsibility of Project Manager										
Project Management										
Business Case										
Benefits Realisation										
Project Initiation Document (Project Charter-PMBOK)										
Strategies to Address Slippage Problem										

Exam Topics	P/P	06/12	12/11	06/11	12/10	06/10	12/09	06/09	12/08	06/08	12/07
Project Planning & Management Tools											
FINANCE											
Ratio Analysis											
Divisional Performance Measures											
Investment Appraisal Techniques											
Coefficient Of Correlation											
Coefficient of Determination											
Forecasting Using Regression Analysis											
Time Series Analysis											

Above analysis is given to emphasize the comparative importance of each topic. This analysis can be used as guide for allocating time to topics accordingly.

Do not attempt to guess future question paper from this analysis, as this is historical data and it is not helpful for reading examiners mind at a time of setting exam paper.

Also, see how different exam topics are examined together in single question.

Exam Topic 1:

STRATEGIC PLANNING & DEVELOPMENT

Sub Exam Topics

S.no	Headings (click the cross-ref below for easy navigation)	Pg.no
1	Organizational Mission, Goal, Objective, Strategy & Budget	43
2	Strategic Planning	44
3	Strategic Lenses	48

Exam Awareness

This exam topic is rarely examined. However, if it is examined, then it is most likely to be examined in section A, which has no choice. Therefore, it has worth spending some time.

It provides the basic knowledge on strategy, which is essential for studying subsequent exam topics.

See [past paper analysis](#)³⁹ to explore relationships between exam topics. You can use this relationship to gather relevant points across the exam topics that can be used to answer questions.

1 Organizational Mission, Goal, Objective, Strategy & Budget

Exam	Q.no	Requirement	Marks
06/12	Q1:c	Advise the Hammond family on the importance of mission, values and objectives in defining and communicating the strategy of Hammond Shoes.	12

Planning	Purpose	Duration	Nature	Origin	Examples
Mission or vision statement	Sets purpose, stakeholders, culture and ethical values. Frame work for other documents as below.	Long term never ending. However, it can be revised.	Narrative	Top level such as owner or board of directors.	Mission of ACCA is to promote Accountancy profession and safe guard its members interest and society at large.
Goal	Sets direction. Motivational.	Long term, never ending. However, it can be revised.	Narrative	Dream of organizational leader or founder, CEO or chairman.	Goal is the dream comes in the mind of the entrepreneur like "I want to be the best accountant in the world"
Objective	Sets future position & Practicable as it is based on organization position in the macro environment.	Long term normally 1 to 5 yrs.	Specific Measureable Attainable Relevant Timely	Top-level managers as they are aware of external forces affecting the organization.	Objectives are financial & non-financial targets "Profitability should be increased two by 20% in 3 years" and "number of services provided should be increased by 30% in 2 years" respectively.
Strategy	Way to achieve future position. Strategy is the thoroughly considered plan among various alternatives options.	Short term. However, it may be revised to account for changing circumstances.	Narrative.	Organizational level depends on the corporate, business or operational strategy being considered.	There can be following options available from which any course of action can be selected as strategy. However, organization may pursue more than one strategy at same time. Option 1. Sell existing products Option 2. Design new products Option 3. Sell others products.

Planning	Purpose	Duration	Nature	Origin	Examples
Budget	Breaks strategy into short-term targets. It allocates resources to implement the strategy.	Normally 1 yr. However, it can be reviewed quarterly.	Forecasted Quantitative & financial data.	Tactical managers. It can also involve participation of operational managers.	Budget can contain either revenues or expenditure or both. Example: Sales budget, production budget and master budget.

2 Strategic Planning

Exam Support:

See student accountant article 07 Feb 2008 'Strategic planning'

Strategic planning is the formal and documented planning to translate organizational objectives in actionable components.

It is long term planning takes account all relevant factors like resources, competencies, macro-environment and expected future changes.

It forms the basis on which operational planning can be made.

Operational planning is short term planning takes account of day-to-day difficulties in implementing strategies.

Strategic planning focuses on wider areas such as selection of market(s) to sell products, develop new products, or continue with existing products.

Strategic planning can be best done at top management level. Strategic level managers are sitting at top of organizational hierarchy can take wider view of organizational performance. They are not involved in day-to-day management; therefore, they can focus their attention on external environment affecting organization performance.

1.1 Rational Approach to Strategic Planning

There are commonly three stages involved in strategic planning.

- Strategic position analysis.
- Strategic choice.
- Strategic action or implementation.

Diagram:



1.1.1 Criticisms on Rational Approach to Strategic Planning

Diagram:

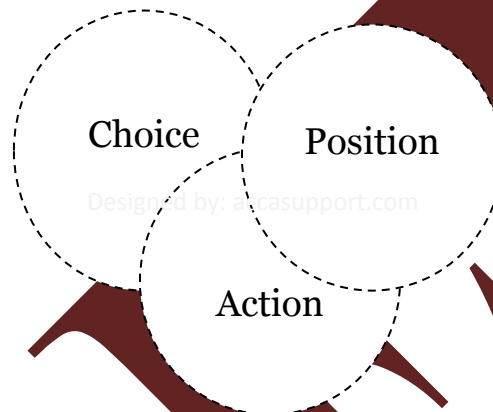

Traditionally, it was suggested that rational planning is the only best approach for strategic planning. However, subsequent writers on strategic planning have proposed different approaches. These are effectively variations of the rational approach.

1.2 Concurrent Approach to Strategic Planning

Mintzberg argued that performing accurate strategic analysis in advance is impossible. It is not possible to anticipate all the factors affecting organization. He believed that strategies emerge while performing organization activities.

Experience enables senior managers to understand the macro-environment in which organization operates and competencies & resources required by the organization. In the light of experience obtained, they can gradually improve and amend their ways of doing things. Trying to identifying every possible factor affecting the organization in advance is waste of time and money.

In addition, macro-environment is subject to frequent change and uncertainty. Circumstances may change any time, which can render

existing strategy unfeasible. Therefore, it will require extra time and money to revise existing strategy.

Example:

Change in foreign exchange rates can decrease demand for exports. As a result, production schedule may need to be changed.

Mintzberg argued that strategic planning should be performed on concurrent basis rather than pre-planned basis.

Diagram:



1.3 Incremental Approach to Strategic Planning

Lindblom argued that managers might not have sufficient time and energy to consider every possible course of action. Managers usually prefer to start with good strategy rather than perfect strategy.

He believed that the best strategy is the extension of past practices. Organizations should adopt strategy in light of previous experiences rather than from zero.

In addition, strategies decided by top-level management without facing challenges from lower levels (tactical and operational) of organization are unlikely to happen in practice.

Example:

Sales manager at operational level may believe that resources available for achieving particular level of sales are insufficient.

Managers should negotiate strategies with lower levels of management and employees.

For strategy to be successful, they should be at least acceptable to employees expected to carry out that strategy.

Feedback from lower level managers can help deciding feasible strategies, as they are better aware of technicalities involved in implementing strategies and day-to-day operations.

Lindblom argued that strategic planning should be performed on incremental basis. It means taking account of previous strategies and their effect on organizational performance.

Diagram:

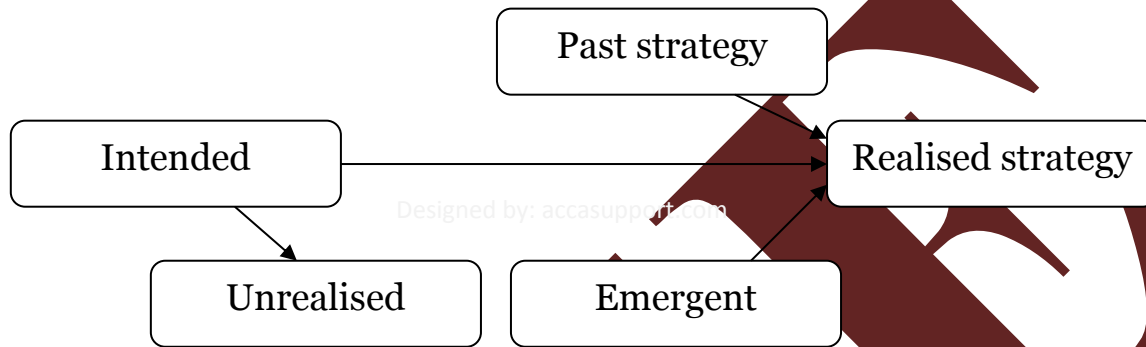

1.4 Ad-hoc (Unplanned) Approach to Strategic Planning

Others argued that strategic planning is not necessary. Opportunities can be exploited whenever it comes. Rigidly following strategy may lead to loss of opportunities which would be uncovered if organization is actively looking for improvement. Strategic planning as periodic exercise will not help to uncover new opportunities.

They consider strategic planning as the time consuming process and against the entrepreneur's attitudes that means enjoying risk taking and problem solving as the business grows.

Particularly, small and medium size organizations (SMEs) may not have enough time and resources to devote to strategic planning.

Newly established organizations may not have enough resources, experience and information available to implement strategic planning process. Strategic planning will waste a lot of managerial time and resource that can be used to promote growth.

According to them, no strategic planning should be performed at all.

1.5 Conclusion

It represents extremely opposite viewpoint to rational approach to strategic planning. Organization can select approach to strategic planning somewhere in between those two viewpoints. Organization should at least consider its external environment, resources, knowledge, skills and experience in reaching a decision.

3 Strategic Lenses

Exam	Q.no	Requirement	Marks
06/08	Q1:c	<p><i>Johnson, Scholes and Whittington identify three strategy lenses; design, experience and ideas.</i></p> <p>Examine the different insights each of these lenses gives to understanding the process of strategy development at the National Museum.</p> <p><u>Note: requirement (c) includes 2 professional marks.</u></p>	10

Johnson, Scholes and Whittington are other very popular writers on strategic planning. They are the modern writers on strategic planning. There all theories are frequently examined.

JSW proposed three strategic lenses for classifying strategic planning approach. However, these are not recommendations for adopting strategic planning approach. It provides guidance to strategic level managers to evaluate their own strategy against these three lenses.

3.1 Strategy as Design

It is top-down approach to strategic decision making. It does not take input from lower level managers involved in day to day operations.

It is similar to rational approach to strategic planning. Strategies are planned taking account of organizational position in the macro environment based on circumstances foreseeable at that time.

Senior management (board of directors) are better aware of external environment and organizational activities. They have communication channels available to exercise control over whole organization.

Strategy as design is cost effective and time saving approach to strategic planning as it does not require negotiation with lower level managers.

Strategic planning is imposed on operational managers; it may create resentment among operational managers. Resentment or demotivation can lead to reduced efficiency.

Strategy as design lens of strategic planning is consistent with authoritarian style of leadership.

It is suitable:

- In turbulent and rapidly changing environment in which quick decision making is required.
- Where major cultural change is required. Strategic managers are in better position to persuade operational managers and employees by the use of their power.
- Where employees do not have enough of knowledge and motivation to participate in strategic planning process.
- For organizations (police & fire brigade etc) where close control is necessary and employee turn-over is higher resulting in inexperienced work force.

3.2 Strategy as Experience

Strategy as experience takes account of previous strategies and their outcomes. It builds on previous strategies and experience for strategic planning for current period. It is similar to incremental approach to strategic planning. It involves updating strategies to account for changes in external environment. In other words, modifying existing strategies to avail new opportunities and reduce threats faced by the organization.

It takes input (knowledge and experience) from those involved in day to day operations regarding challenges faced by the organization in strategic planning.

It is more likely to lead to acceptance by employees as they are involved (giving feedback) in the strategic planning process. Hence, it preserves morale and motivation of operational managers and employees. Morale and motivation is necessary for increasing efficiency of employees.

Strategy as experience is more likely to lead to feasible strategy as based on previous strategies and experience which have already proved their effectiveness.

It saves managerial time and cost by not carrying out planning process from Zero.

Organization need to have some previous experience to implement strategy as experience lens.

It is suitable:

- Where taken-for-granted cultural assumptions are dominant and difficult to challenge existing ways of doing things.
- In stable environment where circumstances do not change significantly which allows previous strategies to be modify without analysing macro environment from zero.
- For risk-averse management. However, it fails to take account of doing better planning than organization has done in the past.

3.3 Strategy as Idea

Strategy as idea requires innovation. These ideas can emerge at any level or anywhere in the organization.

It requires motivated employees to give their views and suggestions and a mechanism to accommodate these ideas into strategy.

It is more likely to lead to acceptance by employees as they are allowed to contribute their knowledge and ideas.

It is best for increasing motivation and morale of employees.

It is considered as risky strategy. It can lead to impracticable strategies.

It is suitable:

- In unpredictable external environment, where ability to respond to unforeseen situations is important.
- For organization developing new product or breaking into different markets to obtain ideas from employees who have experience of particular situation obtain from previous employers or competitors.
- In innovative industries where innovation is the key to success.

Example:

Telecommunication, fashion industries etc.

- For newly established business where owners as well as employees have little pervious knowledge and experience. They can benefit from pooling of knowledge and experience from lower level employees.

FREE

Buy Full ACCA P3 Study Text Book (250±) at ACCASUPPORT.COM | [FB GROUP](#) | [COMMENT](#) | [FORUMS](#) | [JOBS](#)
ACCA F2, F5, F9, PI Study Materials Free Download & ACCA Distance Learning Course & Classes in Karachi



Exam Topic 2:

MACRO ENVIRONMENT ANALYSIS

Sub Exam Topics

S.no	Headings (click the cross-ref below for easy navigation)	Pg.no
1	PESTEL Analysis	53
2	Michael Porter's Five Forces Model	61
3	Michael Porter's Diamond Model	68
4	SWOT Analysis	73
5	Stakeholder Management Matrix	74
6	Considering Response to Stakeholders	76
7	Benefits & Limitations of Mendelow Matrix	76

Exam Awareness

It is regularly examined topic. It was examined in section A, which has no choice. Therefore, you must excel at this exam topic.

It can attract more or less 25 marks in the exam. It is easier compared to other exam topics, as you can produce answers based on experience of organizations to deal with in your general life.

Answers to this exam topic are usually required in the form of reports and memos. Therefore, you can earn additional, up to 4 professional marks.

See [past paper analysis](#)³⁹ to explore relationships between exam topics. You can use this relationship to gather relevant points across the exam topics that can be used to answer questions.

1 PESTEL Analysis

Exam	Q.no	Requirement	Marks
P/P	Q1:a	Evaluate the macro-environment of NMS using a PESTEL analysis.	15
06/11	Q1:a	<p>Universal Motors have explicitly recognised the need for analysing the external macro-environment and marketplace (industry) environment of EcoCar.</p> <p>Required: <i>Analyse the external macro-environment and marketplace (industry) environment of EcoCar. Professional marks will be awarded in part (a) for the inclusion of appropriate model(s) and the overall structure and clarity of the analysis. (4 marks)</i></p>	20
12/08	Q1:a	Analyse the macro-environment of the National Museum using a PESTEL analysis.	20

Exam Support:

In exams, using this framework ensures that you have gathered sufficient information necessary to analyse the strategic position of the organization. Other frameworks are equally acceptable and you can use PESTEL analysis in combination with other frameworks as well.

PESTEL analysis is previously used by the examiner in combination with porter's five forces model discussed next.

PESTEL analysis is frequently examined framework. It is worth spending some time studying it.

You are advised to think as many ways as possible in which organization can be affected by PESTEL factors. Therefore, you can quickly identify relevant information from the scenario.

Managers have to identify changes in macro-environment that influence strategic position of the organization. PESTEL Analysis can be used for the assessment of strategic position of the organization in macro-environment in which the organization operates.

Exam support:

Macro-environment can be replaced by "market" in questions.

Change in PESTEL factors requires organization to change its strategic position. Failure to change its strategic position can lead to loss of competitive advantage in the long term.

PESTEL factors cannot be controlled in the short term. Therefore, organization has to change its strategy to respond to change in PESTEL factors.

Trying to change PESTEL factors even in the long term may prove costly, instead there is no guarantee that organization will succeed.

Macro-environment indirectly affects **all the organizations** operating in particular industry rather than affecting only **particular organization** operating in that particular industry. However, some PESTEL factors may affect *more* to organization operating in particular industry than organization operating in other industry.

Example:

Agriculture industry is highly dependent on rain falls for growing crops, while Accountancy profession (industry) is very less dependent on climate.

PESTEL factors affects profit making organizations as well as not for profit organizations.

PESTEL factors discussed below are interrelated and points discussed for one factor can be used for other factors as well.

Exam Support:

*Instead of writing same point for one and then other factor, you can discuss that point for all the relevant factors at once. It can be done by labelling with respect to **treats and opportunities** rather than **PESTEL factors**.*

1) **Political**

Political environment is associated with government policies and actions

Following are some of the ways in which political factor can affect organization.

- Government can improve economic environment by providing grants and loans to organizations.
- Government can **encourage** or **impose** quality standards by devising **award schemes** or **legislations** respectively.
- Government can attract or resist foreign investment by devising policies such as monetary and fiscal policies.
- Government can raise compliance costs to organization if it frequently revises its policies and legislations. Organizations may have to change their processes to comply with revised policies and legislations.
- Government changing hands frequently can upset investors due to uncertainty regarding policies of new government, while stable government can attract new investors.
- Whether rules and regulations made by the government are polite or stringent. This indicates the vulnerability of the organization to legal risk such as fines and penalties (it can also be discussed under legal factor).
- Government can protect or damage home industry by setting import & export duties and quotas.
- Government can create new employments in under developed areas by investing its own revenue (tax income).
- Government can improve technological environment for organization by providing infra-structure such as sewerage, transportation, energy, wireless networks etc.

2) Economical

Economic environment includes financial performance, employment levels, customers, suppliers, supply & demand in markets.

Both profit making and non-profit making organizations needs to be economically (financially) sound.

Not for profit making organizations exist to pursue non-financial objectives rather than economic growth. However, they need to be economically sound to achieve those objectives.

Economic factors can **deteriorate** or **improve** due to **deterioration** or **improvement** in other factors such as political and legal factors etc.

Example:

Government monetary policy (interest rate & foreign exchange) can encourage or discourage new investments and spending.

Following are some of the ways in which economic environment can affect organization.

- Business cycle affects revenue and market growth of the organization in the short term depending on the stage from which the business is suffering. The stages are depression, recession, recovery and boom.
- Industrial cycle, affects revenues and market growth of organization in the long term depending on the stage from which the industry is suffering. The stages are introduction, growth, maturity and decline.
- Economic strength of organization depends on access to resources such as finance, human resource, materials and equipment at reasonable cost. In addition, material needs to be available in time when required and equipment along with after sales service.
- Availability of suppliers and their bargain power affects organizational economic strength.
- Market demand for goods or services which organization offers.
- Taxation policies i.e. direct or indirect taxation and tax rates.

Example:

High tax rate will leave little for reinvestment or distribution to shareholders as dividend.

- Inflation, interest rate and foreign exchange rate.
- National income can also influence market demand for the organization's goods or services.
- Level of unemployment in the country, high unemployment puts employer in dominant position and can negotiate low wage rate with workers.

→ Stock market condition such as investor confidence in stock exchange affects demand for shares of the organization. Rising demand of shares in the stock market may lead to easy availability of finance at reasonable cost.

3) Social

Social environment includes with age, sex, race, culture, language, individual income, taste, fashion and behaviours of human beings etc.

Social factors can influence political factors.

Example:

Active participation of public will lead to government trying to act in the best interest of public.

Following are some of the ways in which social factor can affect organization.

→ Demand, taste and behaviour of the society affect quality and specification of the goods or services of the organization.

Example:

Customers, financiers and suppliers may not support organization selling poor quality products.

→ Society can support or boycott organizational goods or service depending on how society perceives its impact upon them. These perceptions can be improved by good public relation practice.

→ Increasing or decrease population affects organization's decision on investment or divestment to particular industry in it operates.

Example:

Increasing population suggests higher demand for younger people products such as toys, sports goods etc while decreasing population suggests higher demand for older people products such as surgical goods.

→ Attitudes of workers affect cost and profitability of the organization.

Example:

Workers commitment to their work or mere compliance with standards depends on social environment in which organization operates.

- Healthy workers are more productive than overstressed workers. Health of the workers depends on society from which organization recruits them.
- Income distribution affects the organization choice of market segment and customer group. Income distribution means how wealth in the country is scattered among individuals. Even distribution suggests that most of the people may buy products offered by the organization. However, people may not afford highly priced product. On the other hand, uneven distribution suggests that only minority of the people can buy product offered by the organization. However, minority of the people may afford highly priced product.

4) **Technological**

Technological environment is associated with learning and innovation.

Social environment can influence technological environment, while technological environment can influence environmental and social environment in turn.

Example:

Search engine is the invention of well-educated and innovative computer specialists of the society, while it is affecting the way society search for information i.e. by using search engines over the internet rather than visiting public library.

CO₂ emission from automobiles has great impact on environment.

- Organizational capital expenditure, quality of products and selling prices depends on either technological environment is **stable** or rapidly changing. **Rapidly changing** environment suggests **shorter product life** cycles and **higher replacement cost** of plant & machinery while **stable** environment suggests opposite.
- Technological developments may permit doing organizational activities more efficiently, economically and effectively. Organization

may automate its activities, this in turn may affect other factors such as social and economic factors.

→ Innovation can lead to boom in the economy and it can affect society as well.

Example:

Facebook is changing the way people meet each other and conduct business.

YouTube is the product which affects the way people acquire information.

5) Environmental

Exam Support:

Do not be confused with term environment with macro environment or external environment. Macro environment or external environment is surroundings of organization. However, environment is one of the factors found in macro environment or external environment.

Word environment is also used in sense such as economic environment. In that case, examiner is using word environment to describe economic factor in macro or external environment.

Environment factor includes natural resources, climate, wildlife, catastrophes etc.

Environmental deterioration or improvement is related with technological advancement, environmental legislations (legal factor) and people attitudes toward environment (social factor).

Following are the ways in which environment can affect organization.

→ Greenhouse effect has affected the way organization operates such as increasing demand on organization to develop environment friendly products.

Example:

Society is increasingly using hybrid cars and paper bags instead of plastic bags.

Eco friendly fonts, such as Century Gothic that uses lesser ink and money; instead of traditional fonts such as Times New Roman and Arial etc.

- Increased emphasis on environmental and sustainability reporting. It forces organization to operate in environment friendly way and change their internal controls, communication lines, organizational structure, organization processes etc.
- Environment legislations being enacted. It forces the organization to change its policies and practices. It also leads to increase in environmental cost of compliance, information gathering and reporting environmental performance.

Example:

Legislation requiring safe disposal of wastes, such as dumping garbage in mid sea, leads to increased disposal costs to organization.

6) Legal

Legal environment includes rules and regulations.

Revision

Regulation is any form of interference in free operation of market or external environment.

Legal factor is related with political or social factors.

Example:

If society is self-disciplined, then there will be little need for rules & regulations.

If politicians are corrupt they may not update rules and regulations to respond to changing external environment.

Following are the ways in which legal factor can affect the organization.

- Competition law imposes restriction of mergers and acquisitions to promote competition. Competition encourages organization to operate efficiently to sustain in market and achieve competitive advantage. Competitive advantage is the ability to earn profits above industry average.

- Employment legislation protects rights of workers by setting minimum wage requirements, anti-discrimination and anti-harassment legislation, health & safety legislation etc to protect workers. It changes the way organization deploys their workers.
- Imposing high import duties to protect home industries. It limits organizational profitability from imported goods or manufacturing of finished goods require imported raw materials.
- Licensing requirements enforce organizations to maintain quality of standard set by the law in order to get licence to operate in particular industry. Licensing requirements also affect the level of competition in the market.

2 Michael Porter's Five Forces Model

Exam	Q.no	Requirement	Marks
P/P	Q1:b	Analyse the industry or marketplace environment that NMS is competing in.	16
12/09	Q1:a	Xenon usually analyses an industry using Porter's five forces framework. Using Porter's framework, analyse the business analysis certification industry (BACTI) in Erewhon and assess whether it is an attractive market for ABCL to enter.	20
06/08	Q1:a	Using an appropriate model or models, analyse the competitive environment of AutoFone's retail shops division. Note: requirement (a) includes 2 professional marks.	20

Exam Support:

*Five forces model can be used alone or in combination with **PESTEL**⁵³ framework to analyse organization's strategic position in the macro-environment.*

Exam question can also use market, external environment instead of macro-environment.

You should be familiar with different technical jargons used to address the same situation.

Porter's five forces model can be used to determine competitive position or strategic position in market or macro environment.

Forces given below are inter-related. Therefore, information used to assess one force can be used to assess other forces as well.

Diagram:

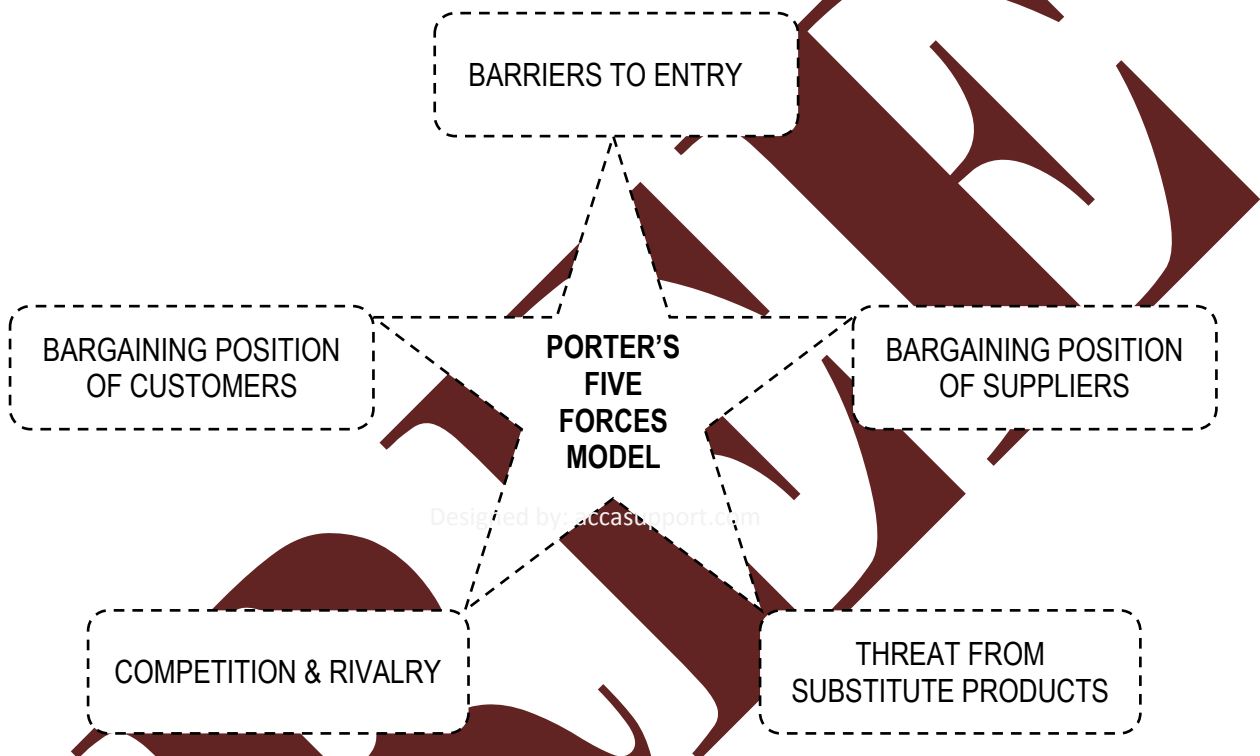

1) Bargaining Position of Suppliers

How strong or weak position of organization is in comparison to its suppliers.

Bargaining position of suppliers can be assessed in terms of:

Size of the organization in comparison to its suppliers. If organization is large in comparison with suppliers, then position of organization is stronger than its suppliers. Organization can take longer to pay its suppliers and can contract with suppliers on its own terms & conditions.

Example:

Large companies contract with suppliers by inviting tenders. Tender document lists the terms & conditions which must be agreed by suppliers to supply goods or services.

Availability of goods (raw materials or finished goods) and services required by the organizations. Shortage of raw material and services required by the organization gives strong bargaining position to suppliers. In times of excess demand for goods or services, suppliers may consider selling first their goods or services to their key customers. Therefore, organization has to maintain relationships with suppliers to be able to ensure continuity of goods or services supplied to the organization.

Competition among suppliers also influences bargaining positions of organization. If competition among suppliers is fierce, then organization has strong bargaining position than suppliers. It will be easy for the organization to switch to different supplier. Therefore, organization can negotiate bulk purchase discounts, trade discounts and favourable credit terms etc with suppliers easily.

Area of organizational activity dependent on supplier affects position of organization. If supplier is providing goods or services to the core activity of the organization such as production, sales & marketing, then bargaining position of supplier is stronger than the organization. Contrarily, if supplier is providing goods or services to the supporting (non-core) activity of the organization such as accounting, information technology etc, then bargaining position of organization is stronger than suppliers. Organization can discontinue or automate that supporting activity or switch to different supplier as strategic position of organization will not be affected significantly by discontinuing or switching to different supplier.

Complexity of goods or services provided by the supplier also affects bargaining position of organization in comparison with supplier. If goods or services are of complex nature, then bargaining position of supplier is stronger than organization. Organization may not be able to provide those goods or services in-house due to lack of resources (man, materials, money, and machinery), competencies (knowledge, skills & experience), licence etc.

2) Bargaining Position of Customers

Bargaining position of customers is opposite to bargaining position of suppliers.

Customer can be individual person or organization.

Bargaining position of customers can be assessed in terms of:

Organization's size in comparison with its customers affects bargaining power of customer. If organization drives majority of its revenue from small number of large customers, then bargaining position of customers is stronger than organization. Loss of few customers will result in wide fluctuations in profitability.

In that case, large customers can invite tenders, so that they can purchase from the organization offering lowest prices and most favourable terms such as credit period and after sale services. Organization has to provide value for money (economy, efficiency and effectiveness) to its customers to achieve competitive advantage in the industry.

However, if organization drives majority of its revenue from large number of small customers then bargaining position of organization is stronger than customers. Organization will not be dependent on particular customer for its profitability. Loss of a customer will not affect profitability of the organization significantly.

In that case, organization may choose to charge premium prices to take advantage of its strong bargaining position.

Availability of goods or services affects the bargaining position of organization. If goods or services are in scare supply, then bargaining position of organization is stronger than customers. Organization can charge higher prices for its goods or services.

However, if goods or services are in abundance, then bargaining position of customers is stronger than organization. Organization has to provide reasonable prices, quality and after sales service to customer to retain and increase customer base (market share).

Competition among organizations operating in the industry affects bargaining position of organization. If competition is fierce (cut throat) then bargaining power of customers is stronger than organization. Customer can easily take their orders elsewhere for higher quality or reduced prices.

However, if organization has monopoly position in the market, then organization can charge higher prices and do not have to be very much concerned about quality. It can happen when customer have no other substitute products to get the same benefit. However, it could be risky in the long term; if any substitute to product offered by the organization arises, then customer will show his/her resentment by switching to substitute goods or services offered by competitors.

Importance of goods or services offered by organization to customers affects the bargaining position of organization. If goods or services are of necessity, then bargaining position of organization is stronger than customers. Customers cannot abandon the use of goods or services even in times of economic recession (down turn).

However, if goods or services offered by the organization are of luxury, then bargaining position of customers is stronger than organization. Customer can abandon the use of goods or services in times of economic recession. Organization has to reflect this fact in its selling prices. In times of recession prices may be lower than normal, while in times of economic boom (up turn) organization may charge premium prices. Customers spend their residual income on luxuries after satisfying necessities due lack of importance to customers.

Complexity of the goods or services affects the bargaining position of organization. If organization is selling very complex (knowledge intensive or technical in nature) goods or services, then bargaining position of organization is stronger than customers. Customers may not have technical know-how of the goods or services. Customers may be not able to compare price and quality with goods or services offered by competitors. Therefore, organization can charge higher prices for goods or services. However, if an organization is selling simple goods or services, then customers' bargaining position is stronger than organization.

3) Competition & Rivalry

Competition and rivalry affects the strategic position of organization in following ways.

Competition and rivalry increases costs to the organization, as more marketing expenditure will be required to create brand loyalty and

reputation of organization among customers to stand out from competitors.

Prices may have to be decreased to maintain and increase market share (number of customers in existing market).

Research and development expenditure have to be increased to devised new products to cope with products offered by competitors.

Competition and rivalry also forces organization to work more efficiently and provide better quality product to obtain an advantage over competitors. Managers will be forced to reduce unnecessary costs such as wastage and idle time to increase profit margin, because profit making through increasing selling prices may not be possible.

Competition and rivalry affects the generic (original) strategy and subsequent strategies followed by the organization.

Example:

Presence of intense competition in the market may force organization to adopt differentiation strategy (generic strategy) and may force organization to expand overseas or acquire existing competitor organization (subsequent strategy).

4) **Barriers to Entry**

Barrier to entry is favourable force for organization already operating in particular industry. However, it is adverse force for organization considering entry in particular industry.

Exam Support:

Look for information in the scenario whether organization is already operating particular industry or considering entry in particular industry.

Barriers to entry can be assessed in terms of:

Legal environment such as licensing requirement can act as barrier to entry.

Example:

Membership required of a recognized accounting body to act as tax consultant.

Tax rules for organizations that are considering expanding to foreign market.

Economic environment can act as barrier to entry. Initial capital expenditure required to initiate the investment project and ability of the organization to raise capital.

Example:

Some industries, such as telecommunication require significant initial capital expenditure to install communication networks.

Above barriers provides affects more significantly to small & medium sized organizations (SMEs) which do not have know-how of legal requirement and do not have enough money to invest in such resources.

Fierce competition can also act as barrier to entry because the potential competitors will finds it difficult to create market share to achieve enough return of capital employed (ROCE).

Political environment can act as barriers or facilitator to entry.

Example:

Government trying to develop particular industries can attract organizations by providing grants and loans.

Technological environment such as complex/knowledge intensive/high-tech goods or services also act as barriers to entry in particular industry can act as barriers to entry.

Example:

Education industry has barriers to entry because of having qualification's requirements such as ACCA.

Social environment such as attitude of people towards new organizations and new products can also act as barrier or facilitator to entry.

Example:

People may not want to risk their money by buying cloths of new fashion house.

5) Threats from Substitute Products

Threats from substitute products can be judged in terms of:

Buy Full ACCA P3 Study Text Book (250±) at ACCASUPPORT.COM | [FB GROUP](#) | [COMMENT](#) | [FORUMS](#) | [JOBS](#)
ACCA F2, F5, F9, PI Study Materials Free Download & ACCA Distance Learning Course & Classes in Karachi



Number of alternative products that customer can use instead of using existing product.

Example:

It can be Glass mugs and steel mugs, if glass mugs are getting higher in prices than customers can use steel mugs.

Another thing to consider is switching cost of the product to the customer.

Example:

If buses fare increases it will be difficult for travellers to switch to different mode of transport like purchasing their own vehicle because it will involve substantial investment, which everyone cannot afford.

Some products are like above can be easily switched but some products which require training and have lack of resale value are difficult to switch.

Example:

If software supplier increases its service charges to upgrades, then organization cannot easily switch to different software supplier without spending time and money on training employees.

If laptop manufacturer increases price for spare parts such as power adapters, keyboard pad etc, then it becomes difficult to switch to other manufacturer without incurring significant loss on resale.

3 Michael Porter's Diamond Model

Exam	Q.no	Requirement	Marks
06/10	Q2:b	Examining using Porter's Diamond the factors which could influence organization's decision to move a large part of its logistics business.	10

Exam Support:

You can use this framework to identify reasons for success or failure of organization in the scenario.

Porter's diamond is the framework explains the reasons behind the competitiveness of nations in particular industry.

Example:

Japan is well-known for consumer electronics, Germany is well-known for Cars and United Kingdom is well-known for financial service provision.

These elements are inter-related and overlapping in nature.

Diagram:

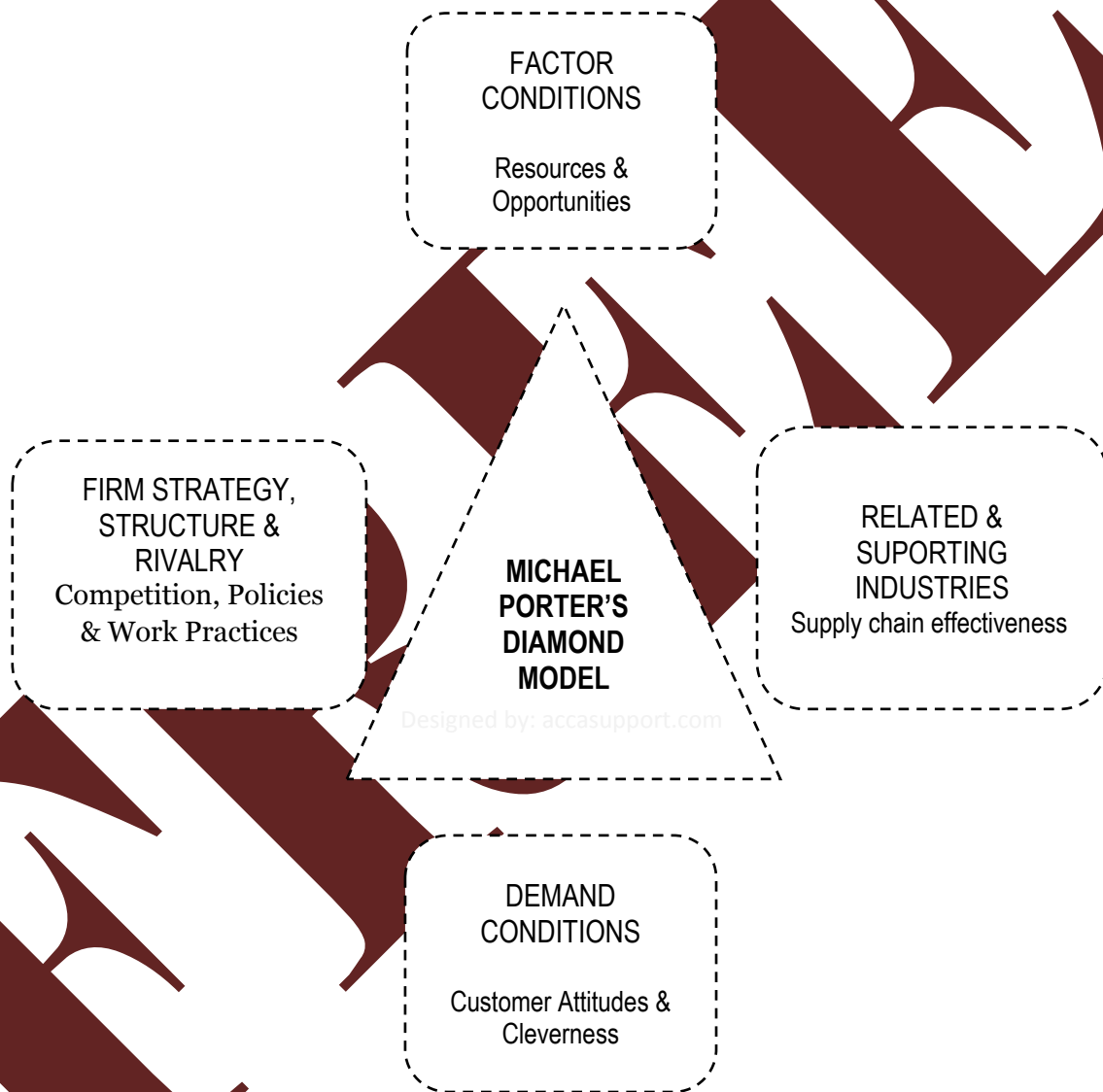

1) Factor Conditions

It means availability of infra-structure, resources and opportunities such as electricity, natural resources, atmosphere, geo-locations etc which can be pre-requisite for operating in particular sector.

Example:

Natural resources such as flowers helped France to become leading quality fragrance supplier in the world.

Atmosphere such as hot climate helped Saudi Arab to grow quality dates.

Geo-locations such as lush green landscapes and mountains helped in development of tourism industry in Switzerland.

All these factors are beyond the control of the organization. These factors are a source of competitive advantage to organizations because other organizations and industries situated elsewhere in the world cannot buy or develop such factors in the short term.

Example:

Organization can relocate itself in particular country ideal for growth of organization in the long term.

Government can develop infra-structure to help growth of organizations in home country.

Factors such as skilled labours, machinery, investment etc necessary for organizational growth can be arranged to achieve competitive advantage but these can also be obtained by other organizations in short term. Therefore, it cannot be used to achieve long-term competitive advantage.

2) Demand Conditions

Customer having cleverness and knowledge of the industry and products will force organization to focus on quality and cost reduction.

Customers demand and attitude regarding ability to try new products force organization to develop innovative products to achieve competitive advantage over local and foreign suppliers.

Early maturity of markets in home country than other countries forces organization to expand in foreign markets where demand for organizational products is still in growth phase.

Educated and demanding customers motivate organization to research and develop new products, which can be sold to local and foreign markets.

All these ultimately help to achieve competitive advantage in foreign markets.

Background of the people in a region and education level of the people all influence demand conditions. Demand conditions cannot be changed in short term but it may be changed in long term.

Organization cannot do much about changing demand conditions. However, it can be changed by politicians by raising education and employment level in the long term.

3) Firm Strategy, Structure & Rivalry

It means market condition i.e. monopoly or perfect competition. Having monopoly in the market gives no incentive to organization to gain efficiency. On the other hand, presence of successful competitors in the industry encourages organization to improve its efficiency.

Political and legal environment can influence competition in particular industry

Example:

Giving subsidies and tax relief for organizations operating in underdeveloped industry.

It cannot be controlled by organization. However, government can attract new entrants to encourage efficiency.

Firm (sound) strategies help organizations to operate effectively and grow without any interruption.

Example:

Pricing strategy based on marginal cost helped automobile manufacturers in Japan to build largest market share in US.

Adoption of generic strategies (cost leadership, differentiation and focus) also influences the success or failure of organizations in international markets.

Example:

Adoption of cost leadership strategy by manufacturers in china helped them to achieve economies of scale and efficiency which provided

competitive advantage and large market share in international markets.

Ferrari Company is the adopter of focus-differentiation strategy which enabled them to become leading manufacturer of high quality sports cars in the world.

Sound organizational structure established by considering social and cultural factors leads to fluent and efficient operations. Some nations have inherent social and cultural advantages, which leads to sound organizational structures.

Example:

In Japan ability to work in teams, flexible timings, no retirement age limit helped organizations to become leading consumer electronics supplier by achieving economy and quality as compared to organizations in rest of the world.

These factors can be changed by organizations through learning from already successful organizations in that industry.

4) Related & Supporting Industries

Organizations require upside and downside supply chains to operate successfully. Availability of efficient suppliers helps the organization to focus on core activities while outsourcing its supporting activities. Efficient suppliers will provide quality service at lower cost than organization.

Example:

Natural juices manufacturer requires fruit pulp, but they may not have competencies in farming. If agriculture and farming industry is strong in that country they can buy fruits from farming organizations and concentrate on its core competencies such as extraction of juices from pulps.

Similarly, availability of efficient distributors helps organizations to offer its products to remote and foreign markets. Efficient distributors will deliver products at low cost and in timely manner.

Competitors also support organization to acquire necessary knowledge and skills. Employees changing their employer can transfer knowledge, skills and experience related to industry to other organizations.

Supporting and related industries can be encouraged and developed by government in the long term. It is beyond the control of organization.

4 SWOT Analysis

Exam	Q.no	Requirement	Marks
12/11	Q1:a	Using appropriate models and frameworks, analyse GET's current strategic position from both an internal and external perspective.	20
06/09	Q1:a	Evaluate the current strategic position of <i>greenTech</i> using a SWOT analysis.	12
12/07	Q1:a	Using the information provided in the scenario, evaluate the strengths and weaknesses of ONA and their impact on its performance. Please note that opportunities and threats are NOT required in your evaluation.	20

Exam Support:

SWOT analysis summarizes all other frameworks. If you are using SWOT framework, then do not use any other framework in combination with it. This will lead to repetition of same points more than once and will earn no additional marks.

Strength and weakness are factors internal to the organization, while opportunities and threats are the factors external to the organization.

Opportunities and threats are factors outside the control of organization. Organization must change itself to be able to respond to changing opportunities and threats.

1) Strength

Strength is the ability of organization to perform certain organizational activities better than competitors.

Strength is associated with having **strategic capability**¹¹⁵ (resources and competencies).

Strength can be used to exploit opportunities, minimize weaknesses and threats.

2) Weakness

Weakness is the inability of organization to perform certain organizational activities comparable to competitors.

Weakness is associated with not having sufficient strategic capability (resources and competencies).

Weakness should be identified and minimized.

Outsourcing is one of the ways to eliminate weakness.

3) Opportunity

Opportunity is a package of benefits and limitations.

Opportunity should be analysed for effectiveness toward achievement of organizational objectives.

Opportunities can be exploited to grow and maximizing strength.

4) Threat

Threats should be identified to minimize foreseeable risk and losses.

Identification of threats can lead to identification of opportunities as well.

5 Stakeholder Management Matrix

Exam	Q.no	Requirement	Marks
12/09	Q1:c	Identify the stakeholders in Ecoba Ltd and analyse how ABCL could successfully manage them during the ownership transition.	10

Mendelow matrix is a framework for identification & management of stakeholders. Stakeholders frequently change their position from time to time and situation to situation. Therefore, stakeholder's identification and management should be continuous activity rather than one-off activity. Management should be try to reposition stakeholders to lower quadrants and resisting stakeholders from moving towards higher quadrants.

Diagram:

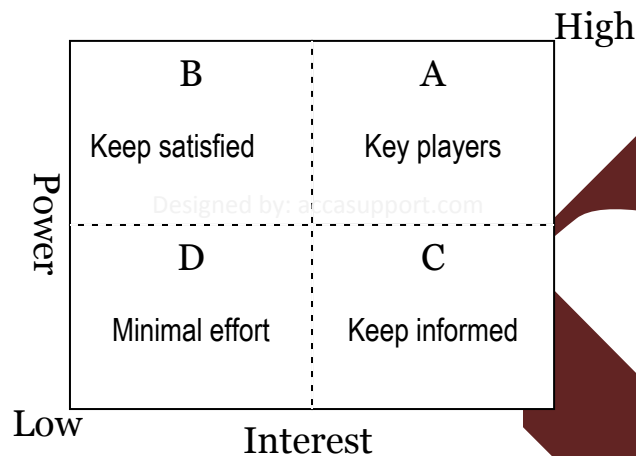

It analyses stakeholders in term of power at one axis and interest at other axis. It has four quadrants.

1) **High Power/ High Interest**

These are key players. Organizational strategy should always be acceptable to them. Example could be a major customer.

2) **High Power/Low Interest**

These stakeholders should be kept satisfied. Otherwise they will be motivated to exercise their power.

Example:

Institutional investor reacting on low dividend policy by voting to remove CEO in AGM.

3) **Low Power/High Interest**

These stakeholders should be keeping informed. They can increase their power by combining with other stakeholders.

4) **Low Power/Low Interest**

Minimal effort should be spent on stakeholders in this quadrant. They are unlikely to affect organizational strategy.

6 Considering Response to Stakeholders

Exam Support:

At least half of the marks are for assessing (application of knowledge) and remainder are for explaining (knowledge).

Rote learning text will not help you pass the exams. You should understand and relate various exam topics.

Wider coverage of knowledge is important; do not skip any exam topic. To expand your breadth knowledge read student accountant articles and practice past papers.

Legitimacy of stakeholders being affected or can affect the organization should be considered.

Power of stakeholders should be considered such as legitimacy grants power to take legal action against the organization.

Level of interest should be considered. If stakeholders are highly affected or can affect, then they need thorough response.

Urgency of stakeholders requiring response from the organization should be considered. If stakeholders have given limited time then they are likely to be very much interested.

Organization values, norms and codes should be considered when deciding response to stakeholders. To determine values and norms look into the history of organization.

7 Benefits & Limitations of Mendelow Matrix

Benefits	Limitations
Potential opportunities and threats can be known in advance. It means facilitators and blockers of change can be identified. Facilitators of change can be exploited to overcome blockers of change.	Mendelow matrix does not consider stakeholders treatment from ethical viewpoint.

Organizational resources can be spent more wisely.	Mendelow matrix considers only extreme situations. In practice, some stakeholders may lie somewhere between these quadrants.
Suitable and acceptable strategies can be devised taking account of key stakeholders.	Mendelow matrix does not consider enough variable such as urgency can be another useful variable which it ignores.
Stakeholders can be managed by repositioning stakeholders to lower quadrants and resisting stakeholders to move to higher quadrants.	Position of stakeholders depends on situation to situation. Stakeholder analysis needs to be carryout before each decision making situation.

FREE

Exam Topic 3:

E-BUSINESS & MARKETING

Sub Exam Topics

S.no	Headings (click the cross-ref below for easy navigation)	Pg.no
1	Marketing	79
2	Push Vs Pull Marketing	79
3	Marketing Mix (7Ps)	80
4	Pricing Strategies	84
5	E-Commerce Vs E-Business	90
6	Basics Terminologies	91
7	Infra-Structure for Information Technology	92
8	Stages of E-Business Implementation	93
9	E-Business Models	95
10	Monetization Methods	96
11	Benefits of E-Business	97
12	Characteristics of Internet Marketing (6 I's)	99
13	Benefits of E-Procurement	102
14	Purchasing Mix (5 Rights)	103
15	Application of E-Procurement	104
16	E-Procurement Models	104
17	EDI Vs Internet	105
18	Drivers (Facilitators) & Barriers to E-Business	106

Exam Awareness

It is not frequently examined topic. It was examined in section B, which has choice of 1 question. If you are running lack of time, then you may move to next exam topic and return if you have additional time.

Frameworks under this topic is not examined specifically, it provides an underlying knowledge for discussion on other exam topics. 6I's, 7P's, 5R's are frameworks that can be used as underlying knowledge.

See [past paper analysis³⁹](#) to explore relationships between exam topics. You can use this relationship to gather relevant points across the exam topics that can be used to answer questions.

1 Marketing

Marketing is the process of creating awareness for organizational products, persuading customers to buy them and maintaining relationships with customers to encourage repeat purchases.

2 Push Vs Pull Marketing

2.1 Push Marketing

Push marketing is the traditional form of marketing in which organization searches for customers to sell its products by persuading them.

It uses marketing media such as TV, radio, newspapers, magazines, banners etc.

Push marketing is considered a costly method of marketing.

2.2 Pull Marketing

Pull marketing is modern form of marketing in which customers searches for organizations to buy products of their own wish.

It uses marketing media such as websites, Forums, subscribed e-mails and SMS etc.

Pull marketing results in high quality targeted customers as they already have an awareness of products related to industry in which organization operates.

Pull marketing is considered as cheaper method of marketing than push marketing.

3 Marketing Mix (7Ps)

Exam	Q.no	Requirement	Marks
12/11	Q4:a	<i>ATL needs to determine the price (or prices) of its e-learning product:</i> Identify and discuss the factors that need to be taken into consideration when pricing the e-learning product.	15
12/10	Q2:b	Evaluate how e-business might help TMP exploit each of the five elements of the marketing mix (price, product, promotion, place and physical evidence) identified by the marketing director.	20
06/10	Q1:c	<i>Sheila Jenkins sees customers as both prospective and existing members, volunteers and donors of WET'. She also wishes to gain increased revenue from each member and donor.</i> Evaluate how email and website technology might facilitate the acquisition and retention of WET's customers and support WET's aim to gain increased revenues from members and donors.	10
06/08	Q3:b	<i>AutoFone's CEO is anxious to develop a rational and well-argued case for retaining the retail shops division.</i> Write a briefing paper for the CEO to submit to the strategy planning committee explaining why the retail shops division should continue to form a key part of AutoFone's future strategy. <u>Note: requirement (b) includes 3 professional marks.</u>	15

Marketing mix includes elements that affect customer perception regarding product quality when it first becomes aware of the organization or its product.

Many of the customers purchase products with reference to brand name rather than name of the organization.

Example:

Customers usually purchase washing power with reference to brand name (Ariel) rather than manufacturer name (Unilever).

Marketing mix is tool for differentiating products of the organization from products offered by competitors.

1) Product

Product (good or service) is the package of benefits that customer expects (needs or desires) to receive from the purchase.

Product is the whole buying experience associated with the purchase of main product.

Example:

Customer may prefer hair dressing saloon which has air conditioner rather than fan.

The buying experience can be regarded as supporting product which influences customer's decision to buy main product.

Example:

Air conditioning in saloon is the supporting product as it provides comfort to customer.

Product is very strong element in marketing mix. There is little chance to persuade customers if the product offered by the organization is not according to expectations of the customer towards satisfying their needs or desires. Even if customer may buy it once, it is very unlikely that they will buy it again. In addition, good product requires less promotional expenditure and can be sold till longer period.

Product should be frequently evaluated for its effectiveness towards customer satisfaction or at least when indicators of changing customer needs, desires, taste, fashion and behaviours are available.

2) Price

Price is the most powerful element in marketing mix to influence market share and market size (demand) of the organization and products in short term.

Price is major element in marketing mix. There is little chance that customers will buy a product, which is beyond their budget no matter how much customers value your product.

Price of the product should not be greater than the Quality (benefits) perceived by the customer from its use.

Pricing strategy adopted by the organization should take account of market segment to which organization is trying to sell its goods.

Various pricing strategies might be adopted some of these include; price penetration, price skimming, market segmentation, captive product pricing, full cost plus pricing, marginal cost plus pricing, target pricing, product life cycle pricing, premium pricing and discounted pricing.

3) Place

Place is the medium chosen to deliver the product.

It must be compatible with product and price as discussed above.

Example:

If product is intangible in nature such as E-book then internet may be the best option and pricing must be set to attract targeted customers around the world.

If product is perishable in nature.

Example:

Fruits and vegetables are usually delivered directly to retail shops by removing intermediaries and they are priced by keeping product quality in mind and delivered to place (small shops or supermarkets) targeted by the organization.

4) Promotion

Promotion refers to the medium chosen to increase public awareness of the product or to increase brand image of the product.

Promotion can be done through appropriate promotional mix (various combinations of promotional techniques) such as internet, television, radio, banners and hand-outs.

Promotional mix should be compatible with marketing budget of the organization, product, price and place.

Below elements of marketing mix are specifically related to service industries.

5) Process

Process is the buying experience (air conditioning, security guards & politeness of salesman or service provider) of goods or services of the organization. In other words, process is the supporting product.

Process is particularly important in service industries, as service itself cannot be inspected in advance before making purchase.

However, quality of service can be determined from process. In service industries, customers go through lengthy process from obtaining information to service provision.

Example:

In insurance industry, customers go through obtaining knowledge on insurance policies, submitting documents, claiming insurance and receiving proceeds.

Insurance companies managed to increase efficiency of these processes by scanning documents to quickly store, retrieve and electronically transfer information from one person to another. It has decreased the time taken in providing service to customer.

6) Physical Evidence

This is an important element of the marketing mix particularly in the service sector where customer usually unable to judge the quality of service in advance.

Example:

In Travel industry, passenger cannot judge the safety and comfort of travel in advance.

There some other ways by which quality of service can be estimated. These can be:

- Office interior decoration.
- Quality of advertisement materials (glossy or rough papers).
- Websites design and graphics (statics or dynamic).

7) People

People are the most important element of marketing mix for long term performance of the organization.

This is particularly important in service sector where customer perception regarding the integrity, knowledge and experience of personnel involved in the provision of services is key factor in determining service quality.

Example:

In health and care industry, patients choose hospital according to perception on competency and integrity of doctors.

4 Pricing Strategies

Exam Support:

Pricing strategies are highly relevant topics for exam purpose. As a management accountant, you should know the relationship between strategy and pricing. Management accountants are involved in pricing of products in organizations. Therefore, you should be able to recommend an appropriate pricing strategy to management.

See student accountant article 09 Feb 2011 'Business strategy and pricing'

Pricing strategies adopted should be consistent with business objectives. Pricing strategies are used to control market share, stakeholders (customer and government), risks etc. Organization may have cultural and ethical viewpoints; pricing strategies should be adjusted for such things. Below strategies do not consider these values and beliefs in their own.

Pricing Strategies are as follows:

4.1 No-Frills Pricing

This type of pricing is suitable for product having only basic features.

It is suitable for targeting price sensitive customers requiring only satisfaction of needs and no luxuries.

Selling price is equal to quality perception of customers.

Organizations following no frills strategy can operate at sufficient profitability. It can be adopted by new organizations trying to compete against well-established organizations to penetrate and build market share in the industry.

4.2 Price Penetration

Price penetration is about charging very low prices to build market share and discourage competition.

It involves reduction in profit margin to attract customers while costs and quality remains intact.

Price penetration is long term pricing strategy.

It is suitable for followers of cost leadership generic strategy.

Profitability is achieved by cost reduction through economies of scale and operating efficiencies rather than charging higher selling price.

This pricing strategy can be adopted by risk averse organizations to ensure sufficient demand for organizational goods or services.

Price penetration strategy also discourages competition through charging low profit margin.

4.3 Discounted-Pricing

Discounted pricing seems similar to price penetration. However, prices are decreased to less extent in discounted- pricing than price penetration.

Example:

Giving discounts to customers for purchasing in bulk to encourage more purchases.

Price discounting is a short term strategy. It may be adopted due to seasonal fluctuations in demand or in order to respond to actions of the competitors.

Example:

Selling of winter goods at discounted prices to empty the stock before season is off.

Reduction in selling price to prevent market share in response to entry of new competitor in the market.

4.4 Price Skimming

Price Skimming is opposite to price penetration. Price skimming is about charging extra ordinary high prices to customers.

This types of pricing strategy is suitable for innovative and luxury goods or services having short product life cycle, so that development expenditure can be recovered quickly by obtaining high cash flows at early stage of product life cycle.

Price skimming is the long term strategy.

It is suitable for followers of differentiation strategy.

Price skimming charges higher prices while keeping the Quality of product at standard level.

It is suitable to target those segments of society willing to pay very high prices to maintain their status.

Price skimming is also suitable for organization having liquidity (cash flow) problems. Cash flow problem can be solved by obtaining cash flows earlier through charging high profit margin. However, it may adversely affect long term profitability of the product.

Competitors may become motivated to sell products offered by the organization.

Price skimming may be adopted by risk taker organizations. It does not ensure sufficient demand for the organizational product.

4.5 Premium Pricing

Premium pricing seems similar to price skimming. However, premium pricing charges only marginally (comparatively less) higher prices.

It is suitable for product having unique in terms of features and higher in quality than products offered by competitors.

Premium reflects the difference in product features & quality in comparison to product offered by competitors.

Example:

Blackberry mobile phones are relative expensive than other cell phones because of its unique features and high quality,

4.6 Captive Product Pricing

Captive product pricing is about selling of main products at low profit margin or sometimes at loss, with the intention of earning profits by selling other subordinate or closely related (like spare parts) products at high profit margin.

Example:

Selling cars at lower profit margins and selling spare parts such as gear boxes, ring piston etc at higher profit margins.

Selling desk jet printers at lower profit margins and selling cartridges at higher profit margins.

Once the customer has brought the main product, they have no option except to replace the main product.

However, replacing the main product would require sufficient investment, which may not be acceptable to customer as having low resale value, which is true in case of printers.

Or customer may not have enough cash in the short term, which is possible in case of cars.

4.7 Optional Product Pricing

Optional product pricing seems similar to captive product pricing. In optional product pricing products are not subordinate or closely related to main product. Customers cannot be forced to buy the subsequent products from the same supplier.

Example:

Selling CPU to customers at low price in expectation, that customers will buy peripherals such as monitor, keyboard, mouse etc also from same organization.

4.8 Price Segmentation

Price Segmentation is about charging different prices to different market segments.

Organization may classify the market segments by geo-location, age, sex, time, income etc.

It attempts to charge different prices in different market segments, according to purchasing power and willingness to buy the product offered by organization.

Price segmentation is also called market segmentation or price discrimination.

It is suitable for the followers of focus strategy.

Example:

Bpp and Kaplan charges lower prices for its learning materials in developing countries.

Some restaurants sell food at reduced prices after 12 am.

4.9 Bundle Product Pricing

Various related goods or services are offered as a package.

Example:

Blender and juicer.

Audit and tax.

This strategy is suitable for organizations selling range of products to obtain cross-selling benefits.

Example:

Combined cost of audit and tax will be lower due to not having to do tax calculations from begining work already performed for audit can be used to provide tax service.

Blender & juicer as a package can be sold at reduced price than selling price of sum of individual products, as components for blender can also be used for juicer. Customer would prefer to buy blender and juicer in a single deal than individual deals in order to save money and space.

4.10 Full Cost Plus Pricing

Full cost plus pricing is the traditional form of pricing set by adding mark-up to the full cost (variable + fixed costs).

It establishes long term product price by ensuring all costs will be recovered.

It is suitable for product where there is no existing market or price of the product must be recovered from one product or batch.

Example:

Bidding for the contract of building construction based on full cost plus pricing as each construction contract is different (non-repetitive) from others.

4.11 Marginal Cost Plus Pricing

Marginal or variable cost plus pricing is suitable for short term decision making.

It is suitable for evaluating one off opportunity.

Example:

Customer has made an offer to buy a product in large quantity at reduced price.

It is not suitable for long term pricing as it does not ensure recovery of fixed cost by absorbing fixed costs into product cost.

4.12 Competitive Pricing

It uses the price offered by competitors to price products. This is applicable where product is similar in nature to competitors in terms of quality, size and weight.

Example:

Peanut cookies and coconut cookies.

It is not suitable for pricing services due to characteristics of the services (intangibility, heterogeneity, simultaneity, perishability). These characteristics make comparison difficult with competitors.

4.13 Product Line Pricing

Product line pricing strategy takes account of whole product range before prices are set.

It attempts to increase overall revenue range of product. It focuses on maximizing revenue from total purchase made by a customer rather than

attempting to maximize revenue from individual product. Total purchase includes current and future purchases made by a customer.

Example:

Retailer selling pens recognizes that customer may buy refills too, so retailer might attempt to increase the combine revenue from each separate sale of products.

4.14 Psychological Pricing

Psychological pricing attempts to take advantage of the human psychology.

In the absence of other information about product quality, people tend to judge quality with price.

In case of highly innovative products customers may not be able to judge the product quality. Therefore, organizations may try to make an impression of quality through attractive packaging and pricing.

Example:

Cosmetics have more packaging cost than the cost of ingredients (chemicals).

Educational institutes such as LBSF charge high prices for its services to make an impression of quality.

5 E-Commerce Vs E-Business

E stands for electronic.

E-commerce involves carrying out organizational activities through the use of electronic communication media such as EDP (electronic data processing), hypertext transfer protocol (http), e-mail, file transfer protocol (FTP), SMS, internet telephony, instant messaging etc.

Organizational activities include promotion, after sales service, sending & receiving other information such as policy manuals, financial statements etc from inside & outside the organization.

E-business involves buying and selling goods or service through the use of electronic communication media.

E-business involves all those organizational activities performed in e-commerce. In addition, it also includes buying and selling, transfer of funds in electronic form.

Difference between e-commerce and e-business is of scope of activities. E-business has wider scope than e-commerce.

6 Basics Terminologies

Exam Support:

Below terminologies are unlikely to be examined directly. However, it is useful for understanding information given in the scenario and for effective discussion.

Internet is the major enabler of E-business and E-commerce.

Internet is collective term used for http, ftp, email, SMS, internet telephony, instant messaging etc

Hypertext transfer protocol is used by websites and blogs. Each website and blog has unique URL (universal resource locator).

By default URL starts with sub-domain name www (World Wide Web). However, organization may choose different sub-domain name. Sub domain name is used for branding and directing visitors to specific part of the website using user friendly address.

Example:

ACCA official website has sub-domain name www2.accaglobal.com

Domain name is alpha-numeric name of host computer to which client computers connected to internet can retrieve information.

Example:

If you are downloading past papers from ACCA official website then your computer is client.

If website is secured via encryption, then it uses https extension before URL where S denotes secured. However, it does not mean that data transfer is secured unless it is certified by reliable digital certificate provider such as VeriSign, Norton, McAfee etc.

FTP is used for transferring multiple files in large memory size.

If FTP is secured via encryption, then it uses ftps extension before URL.

7 Infra-Structure for Information Technology

At minimum application of information technology requires following resources.

7.1 Computer

At least one computer should have high performance and storage capabilities to use it as server. Other computer(s) may contain regular performance and storage capabilities. These computers are referred to as work station.

7.2 Web Server Software

Server software enables two or more computers to communicate with each other. It helps controlling permissions and restrictions of each work station (computer) connected to network.

Internet is the largest of all networks. All the networks ultimately connect to internet.

Computer on which server software installed is referred to as webserver.

7.3 Modem

Modem converts analogue signals into digital data. Computers can only process data in digital form. Modem can be dial up modem, Wireless modem such as Wi-Fi, Wi-Max modem, GRPS modem etc.

7.4 Information System Software

It enables capturing and retrieval of information from the computer.

It usually uses database software such Ms Access, My Sql etc. to store large amount of information.

Modern information system software such as Enterprise Resource Planning ([ERP](#)) integrates various activities such as sales, purchase, accounts, marketing etc.

They use single database for storing and retrieval information rather than separate database for each activity. Therefore, it saves information

processing cost and time by removing the need to input same information more than once.

It has implications in the way organization performs its activities.

Example:

Modern information system has enable management accountants to implement ABC costing due to reduction in information capturing cost. ABC requires detailed information on each activity performed by the organization.

7.5 Internet Connection

It enables to send and receive information around the world.

7.6 Connectivity Tools

Connectivity tools are communication cables, infrared, Bluetooth, Wi-Fi, Wi-Max etc. cables are usually connected through either serial port (COMmunication port or parallel port) or USB (Universal Serial Bus) port.

7.7 Security

Anti-spy and anti-virus software are used for reducing threat of information being accessed, modified, deleted and copied in unauthorized manner.

Storage devices, such as data traveller (flash drive) and external hard drive with encryption facility.

Encryption is scrambling information into format which cannot be processed by computers. Password is required to assemble the encrypted information; to be processed by computer.

Example:

The e-book you are reading currently is encrypted.

8 Stages of E-Business Implementation

See student accountant article 20 Oct 2010 'Strategic use of IT'

Exam Support:

Use below stages to identify the current and proposed stage of e-business for the organization in the scenario.

If you are running lack of time, then you may postpone this topic.

8.1 Communication

Organization uses e-business as a means to communicate with shareholders and communicate their product related to customers.

It can involve the use of emails and organizational website. Or

Organization may consider using CMS (content management system) to manage its contents over the website. See <http://www.joomla.org> for demo.

8.2 Conversation

Organization allows customers to make inquiries through e-mail or on their website and receive replies for inquiries and allows customers to give their feedback.

It can be the use of blogs and forums (notice board or discussion groups) email form, guest book, comments form etc.

8.3 Transaction

Organization sells its goods or services and receives payments online.

It can involve the use of its own shopping cart software (os commerce, zencart, prestashop etc), internet merchant accounts and payment gateways (authorized.net, 2checkout) for credit card possessing. Or

Outsource its payment processing function to external supplier that offers complete solution for selling goods or services and receiving payments online such as www.clickbank.com .

8.4 Integration

Information system in organization is linked to suppliers and customers in the supply chain (value network).

Supply chain is different from value chain. Supply chain includes all the suppliers till end user of the product. Value chain includes all activities such as production, sales, marketing, distribution etc performed by the organization.

It can involve the use customer relationship management (CRM) and supply chain management software. These software(s) provide advanced

communication tools such as support tickets, live chat, real time updates etc and task scheduling tools such as calendars, diaries, appointments, customer/supplier specific information etc.

9 E-Business Models

9.1 Business To Business (B2B)

Under this model, one organization purchases from other organization.

It is applicable to organization selling goods or services of capital nature.

Capital goods or services are used as input to the buyer organization rather than brought for satisfaction of needs.

Example:

Alibaba.com

9.2 Business to Customer (B2C)

Under this model, one organization offers its goods or services at their own website to final customer.

It is applicable when organization is selling consumer goods or services.

Example:

www.accasupport.com

9.3 Customer to Business (C2B)

Under this model, organization invites suppliers at their own website to bid for goods or services required by customer.

Example:

Priceline.com

9.4 Customer To Customer (C2C)

Under this models, customers bids to buy goods or services from other customers. In this model, website owner acts as intermediary (middle man) and receives certain percentage of commission per transaction.

Example:

Online auction sites such as ebay.com (intermediary) allow customers to interact with each other. It gets a commission whenever transaction takes place between customers.

People selling their mp3 players to other people for money.

10 Monetization Methods

There are countless ways of doing Ebusiness. Some of the most popular ways are as follows:

10.1 Direct Selling

It involves charging directly to your customer.

10.1.1 Outsourcing Websites

Outsourcing website involves participants for each sale made on their website.

Auction is very popular monetization method among outsourcing websites.

10.1.1.1 Forward Auction

It allows sellers to quote their minimum selling price for goods or services. It is beneficial for seller because each customer will quote higher prices than others to buy the goods or services.

10.1.1.2 Reverse Auction

It allows buyers to quote their maximum price for goods or services. It is beneficial for buyer because each supplier will quote lower prices than others to win the order.

10.2 Indirect Selling

10.2.1 Paid Advertising

It involves allowing customers to use services free of cost and charging advertisers for placing advertisements.

Example:

Facebook.com, Google+1, Orkut etc

10.2.2 Affiliate Marketing

Referring users of services to other goods or services and receiving commission for each sale.

10.2.3 Pay per click

It requires making your visitors to perform an action such as click on advertisement, signing up to third party website, download a digital product etc.

11 Benefits of E-Business

Exam	Q.no	Requirement	Marks
12/11	Q4:a	<p>HomeDeliver does not have a benefits management process and so a benefits realisation review is inappropriate. However, it does feel that it would be useful to retrospectively define the benefits to HomeDeliver of the new electronic ordering system.</p> <p>Identify and discuss the potential benefits to HomeDeliver of the new electronic ordering system.</p>	7

Improved cash flows as payment is immediately transferred to internet merchant account of organization (Bank account) through payment gateway rather than receiving payments by posts.

Security of cash receipt also increases as it is directly credited to the bank account of organization.

Reduction in information processing cost for various processes (activities) such as accounting, managing people, purchasing, selling, marketing etc.

Increase in revenue by selling directly to customers, which is done by removing intermediaries (distributors, whole sellers and retailers).

Increased customer care and after sales service by the use of CRM (customer relationship management) software. CRM software(s) are available free of cost on the internet. These are available under licenses such as open source, freeware, general public license (GPL). These licenses allow free use. It does not mean free for modification, distribution, changing ownership information etc for software(s) issue

under above licenses. However, organization may use paid software or design its own software to meet its organization specific needs.

Detailed information is available for planning and control by using web analytics, webmaster tools such as Google analytics and Google webmaster tools.

E-business gives increased appearance to organization through official website, social bookmarking and social networking websites etc, in addition to physical means.

E-business also gives perception of large organization through careful website design and search engine optimization (SEO) strategies such as link exchange, careful keyword selection etc.

Wide spread reach to markets around the world at lower cost than traditional marketing such as newspaper and TV.

Internet marketing attracts high quality targeted audience which have already awareness of organizational activities, goods or services.

Example:

Website for ACCA study materials such as www.accasupport.com only attracts those students that are searching for study materials on search engines, forums, social networking sites etc.

E-business allows getting real time information on demand and prices. It enables organization to implement pricing differentiation strategy according to different timings and market segments etc.

Example:

Airline Company may charge less on earlier booking and more on late booking.

Charging less to customers situated in developing countries using country specific web pages.

E-business can enable organization to choose from wide range suppliers around the world.

12 Characteristics of Internet Marketing (6 I's)

Exam	Q.no	Requirement	Marks
06/11	Q4:a	Evaluate how the principles of interactivity, intelligence, individualisation and independence of location might be applied in the e-marketing of the products and services of CAR.	16
06/08	Q3:a	Explain, in the context of AEC, how the marketing characteristics of electronic media (such as the Internet) differ from those of traditional marketing media such as advertising and direct mail.	10

Exam Support:

You can use these characteristics as an advantage of internet marketing over traditional marketing media.

1) Interactivity

As opposed to traditional communication media such as TV, radio, banners etc which provide only one way communication; internet marketing provides two-way communication.

It enables existing customers to get after sales service and potential customers to get knowledge of organizational goods or service through sending inquiry tickets directly from the website.

It facilitates customers to compare product prices and features with different products offered by organization itself and competitors.

E-mail can be sent from supplier's website free of charge, comments can be posted below blog posts and discussion board can be helpful to share information with other visitors (customers) of the website.

Social networking sites e.g. Facebook, Orkut, Twitter etc could be helpful for viral marketing. Viral marketing means promoting goods or services through the voice of customer.

2) Intelligence

Internet based marketing provides opportunity to gather relevant information free of cost by using webmaster tools (many of them available for free) which is unlikely to possible with traditional approach to marketing.

Information may be about number of new visitors and re-visitors, how often they visit, how long they stay on each product page, what are the most popular product pages.

Information gathered from these sources can also be used for traditional marketing as well.

3) Integration

E-business using e-commerce software enables automatic updating of customer database. In addition accounts are updated automatically each time new transaction takes place.

Visitors can get real time information on inventory available in stock and expected delivery time of product.

Most e-commerce software(s) allow more login to more than one user at a time. Therefore, production team can use the real time customer database to obtain information on demand of goods or services.

4) Individualism

Websites can have additional functionality to allow visitors to customize website according to their needs such as changing font size, language etc.

It can save the time and effort of visitors to navigate through goods or services offered by the organization. Thus, it will help to attract new customers and retain existing customers.

It may require initial input of some details, which is used to setup their account with the organization. Each visitor is recognized by details such as username and password, address and e-mail etc. These details can also be used to contact customers to promote subsequent products, off-course with their prior permission.

5) Industry Restructuring

E-marketing resulted in removal of intermediaries from the supply chain.

Whole sellers & retailers are of decreased importance in the supply chain and can be removed easily from the supply chain.

Example:

It is very common for informational products such as e-books, CDs and DVDs etc to remove publisher from the supply chain. Author directly sells to end user or through resellers such as amazon, scribd etc.

While at same time some intermediaries such as courier companies are of increased importance in the supply chain and cannot be removed easily.

Example:

It is very common for selling tangible products of which delivery is outsourced to shipping company.

Online marketplaces such as Clickbank.com have become an integral part of the supply chain. These marketplaces bring buyer and selling together and administer buying and selling process for commission.

6) Independence of Location

E-business can operate from any geo-location and around the clock (24/7).

It can give organization an impression of large entity depending on the design of the website. As customers rarely look for profile and contact information of the organization, unless large sum of money is involved.

It gives flexibility to the organization to re-locate its office to any part of the world. Ideally where administration cost is low, knowledge, skills and resources are easily available.

Organization can work flexibly at any time of the day while pursuing other commitments too, due reduced physical interaction with suppliers & customers.

Organization has access to wider knowledge, skills and experience. Working at home is common for e-business. Organization can attract talent across the whole world. In addition, organizations situated in high wage rate jurisdiction can hire employees from low wage rate jurisdiction to reduce remuneration expense. It also leads to overhead savings such as power, rent, depreciation of equipment etc.

13 Benefits of E-Procurement

Benefits of e-procurement (purchase) are same as for e-business. E-procurement is a component of e-business.

1) Reduction in Costs

It is due to bypassing intermediaries (distributor and whole-sellers) from the supply chain and directly approaching manufacturer.

2) Inventory Management

Inventory can be management more efficiently and economically through integrating information systems with suppliers to implement JIT (just in time).

E-procurement reduces working capital requirement in following way.

E-procurement decreases inventory holding period & cost and save ordering costs by automating inventory ordering. Purchase order is automatically dispatched to supplier whenever inventory fall below specified level (reorder level).

3) Increased Buying Power

E-procurement enables organization to purchase goods or service from suppliers around the world rather than from just local suppliers. Organization has greater choice regarding price and quality of raw materials or finished goods.

4) Fluent Operation

Organization can outsource supporting activities to use its resource to focus on core activities such as production, sales, marketing etc. Increased communication enables organization to control and coordinate activities around the organization.

Suppliers can be briefed for future demand of goods or service and can follow up to ensure time receipt of goods or services. It will increase the organizations ability to meet customer demand.

Information technology has reduced information processing cost and made easier & efficient.

14 Purchasing Mix (5 Rights)

Exam	Q.no	Requirement	Marks
06/11	Q4:b	Explain the principles of e-procurement and evaluate its potential application at CAR.	9

An effective E-procurement system should have following characteristics.

1) Right Price

E-procurement system facilitates price comparison before actual purchase made by the organization to ensure that organization is getting best out of their e-procurement system.

2) Delivery at Right Time

E-procurement system facilitates purchase order being placed automatically whenever inventory fall below level set into the system.

It prevents accumulation of slow moving or obsolete inventory due to lower levels in inventory in warehouse.

3) Right Quantity

E-procurement facilitates purchase order being sent automatically with right quantity of goods. For this e-procurement system should involve human intervention to a minimum.

4) Right Quality

E-procurement facilitates purchase order being sent with right specification of goods.

5) Right Supplier

E-procurement facilitates purchase from only authorized suppliers to ensure above goals are achieved.

It also facilitates purchase only by authorized personnel in the organization.

In addition, e-procurement enables organization to restrict access by unauthorized person to prevent modification, deletion of data; therefore, right supplier, right quality and right quantity of goods or services can be purchased.

It can be achieved by requiring username and password to use e-procurement system.

15 Application of E-Procurement

Precise application and scope of e-procurement model differs from organization to organization.

E-procurement falls in two broad categories.

→ Goods or services for resale or manufacturing.

Example:

Mobile phone companies are usually resellers of GPRS (general packet radio service) provided by other organizations.

In East Asia, electric company such as KESC is reseller of electricity generated by other organization in power sector such as KAPCO, WAPDA etc.

→ Goods or services not for resale or manufacturing.

Type of e-procurement model to implement depends on the following factors:

- Resources and competencies present in the organization.
- Resources and competencies present at suppliers organization.
- Need for physical inspection regarding quality, quantity, price and legitimacy of transaction.
- Risks of unauthorized and wrong purchasing.

16 E-Procurement Models

Following e-procurement model can be considered based on above factors:

16.1 Participating In Auctions

Visiting to B2B or B2C websites depending on the nature of goods or services need to be purchased.

Websites can be quickly and cost effectively searched for relevant information using search engines such as Google.

16.2 Establishing Organization's Own C2B Website

Attracting suppliers to organization website with a view to receive offers for supply of goods or services needed by the organization.

It is suitable for frequently needed goods or services such as goods for resale or raw material for production. However, it can result in significant cost to the organization and benefit may not exceed cost of website design, hosting and maintenance.

In addition, it depends on ability of suppliers to search for organization website.

16.3 Participating in Marketplaces as Buyer to Choose from Range of Suppliers

Organization can find suppliers at third party websites quickly and cheaply (if any). Most marketplaces do not charge any fee for participation. Suppliers usually bear all the charges.

Marketplaces have bulk of goods or service which can make difficult to find relevant goods or services. However, it can be overcome using filters to find goods or services by prices, date listed and relevance etc.

Example:

Marketplaces such as clickbank.com allow registration as buyer free of cost. Registration allows buyer to purchase subsequently without providing same information again.

Suppliers can be sorted by categories, popularity and customer conversion rates, refund (purchase return) rates etc.

17 EDI Vs Internet

EDI has become obsolete technology due to advent of internet. EDI involves the use of hubs and network cables; therefore, EDI can be established within limited area. However, internet can be used to communicate and integrate information systems worldwide.

Supermarkets used EDI to integrate their point of sale system with supplier information system.

EDI enabled them to save considerable cost of inventory management and purchasing.

Suppliers were automatically updated in real time regarding recent purchases and goods in stock. EDI enabled suppliers to serve supermarkets more efficiently due to having information on trend (weekly, monthly and seasonal) and current demand conditions.

However, it has a risk of breach of confidentiality of information to get personal advantage by the supplier or for their other customers, which are effectively competitors for organization.

18 Drivers (Facilitators) & Barriers to E-Business

Exam	Q.no	Requirement	Marks
12/10	Q2:a	Determine the main drivers for the adoption of e-business at TMP and identify potential barriers to its adoption.	5

18.1 Drivers

1) Need to Reduce Costs

E-business reduces information-processing costs by using integrated systems to avoid duplication of work.

2) Need to Increase Profit Margin

E-business enables organization to remove intermediaries from the supply chain by directly offering goods to end consumer. It will save material handling and freight cost to the organization, which is incurred in delivering goods to distributors.

3) Need for Environmental Care

E-business can save millions of papers a year in large organizations due to electrical transfer and transformation of information. It can increase market share price or wealth of shareholders by establishing an image of environment friendly organization.

4) E-Business Adopted By Competitors

It will force organization to adopt e-business to prevent its competitive position.

5) Presence of E-Business Knowledge in the Organization

Existing employee(s) may have e-business knowledge or experience obtained from previous employment. Therefore, ability of organization to adopt e-business without extra cost of training.

18.2 Barriers

Cost of designing a website and intra-structure. These initial costs can be substantial for small organizations.

Maintaining and updating e-business website, software and hardware can be costly and may not exceed benefits such as in case of small retailers.

E-business project will result in cash outflows from date of initiation. However, cash inflows will result after project completion, which can take sufficient time.

Need to assess the impact on relationships with existing distributors, whole-sellers and retailers. E-business can decrease the profitability of distributors from selling goods or services offered by the organization. These distributors may discontinue their relationship with organization. If this happens, then profitability from existing sales can be adversely affected.

Requirement for technical knowledge and skills. Organization may not have these knowledge and skills in-house to adopt e-business and recruitment from outside may not be possible (unable to find IT employees having knowledge of industry) or resented by existing employees.

Existing employees may resent implementation of e-business, because of fear of not being able to learn new knowledge and losing their job as a result.

Risk of hackers' attacks (piracy, modification and deletion of information) and malware (virus, worms and spyware).

Exam Topic 4:

MANAGING STRATEGIC PORTFOLIO

Sub Exam Topics

S.no	Headings (click the cross-ref below for easy navigation)	Pg.no
1	Strategies for Organizational Growth	109
2	Rationale for Corporate Parenting	109
3	Ashridge Portfolio Matrix	109
4	Ansoff's Matrix	109
5	Boston Consulting Group (BCG) Matrix	110
6	Product Life Cycle	110
7	Stages of Product Life Cycle	110
8	Benefits of Product Life Cycle	110

Exam Awareness

1 Strategies for Organizational Growth

1.1 Internal Development

1.1.1 Characteristics of Internal Development

1.2 External Growth

1.2.1 Acquisition or Merger

1.2.2 Characteristics of Acquisition

1.2.3 Oversees Acquisition

1.2.4 Strategic Alliance

1.2.4.1 Characteristics of Strategic Alliance

1.2.5 Franchise

1.2.5.1 Characteristics of Franchise

2 Rationale for Corporate Parenting

2.1 Portfolio Manager

2.2 Synergy Manager

2.3 Parental Developer

3 Ashridge Portfolio Matrix

3.1 Benefits

3.2 Feel

3.3 Alien Businesses (Low Benefit/ Low Feel)

3.4 Value Trap Businesses (High Benefit/ Low Feel)

3.5 Ballast Businesses (Low Benefit/ High Feel)

3.6 Heartland Businesses (High Benefit/ High Feel)

4 Ansoff's Matrix

- 4.1 Penetration (Existing Product/Existing Market)
- 4.2 Product Development (New Product/Existing Market)
- 4.3 Market Development (Existing Product & New Market)
- 4.4 Diversification (New Product & New Market)
- 4.5 Related Diversification
- 4.6 Unrelated Diversification

5 Boston Consulting Group (BCG) Matrix

- 5.1 Star (High Market Growth/High Market Share)
- 5.2 Problem Child/Question Mark (High Market Growth/Low Market Share)
- 5.3 Cash Cow (Low Market Growth/High Market Share)
- 5.4 Dog (Low Market Growth/Low Market Share)

6 Product Life Cycle

7 Stages of Product Life Cycle

- 7.1 Design or Development
- 7.2 Introduction
- 7.3 Growth
- 7.4 Maturity
- 7.5 Decline

8 Benefits of Product Life Cycle

Exam Topic 5:
STRATEGIC CHOICE

Sub Exam Topics

S.no	Headings (click the cross-ref below for easy navigation)	Pg.no
1	Generic Strategies	112
2	Strategic Clock	112
3	Position & Resource Based Strategies	113
4	Strategic Success Criteria (SAF)	113

Exam Awareness

1 Generic Strategies

1.1 Cost Leadership

1.2 Differentiation

1.3 Focus

1.4 Focused- Differentiation

2 Strategic Clock

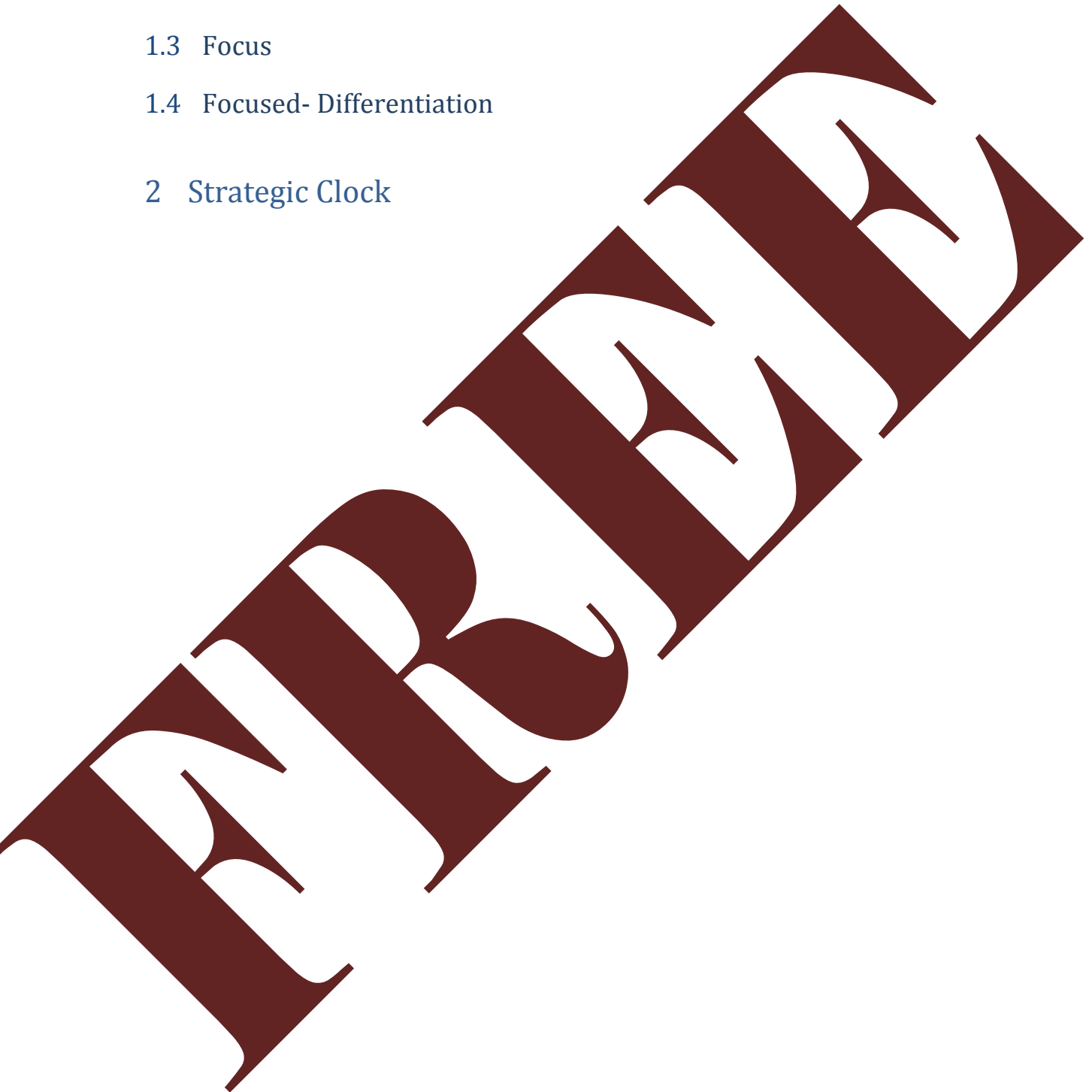

2.1 No Frills Strategy

2.2 Low Price

2.3 Differentiation

2.4 Hybrid Strategy

2.5 Focus-Differentiation

2.6 Failure Strategies

3 Position & Resource Based Strategies

3.1 Position Based Strategies

3.2 Resource Based Strategies

4 Strategic Success Criteria (SAF)

4.1 Suitability

4.1.1 Corporate or Strategic Level

4.1.2 Business or Tactical Level

4.1.3 Operational Level

4.2 Acceptability

4.3 Feasibility

Exam Topic 6:

MANAGING PEOPLE & ORGANIZATIONAL STRUCTURE

Sub Exam Topics

S.no	Headings (click the cross-ref below for easy navigation)	Pg.no
1	Roles of Business Analyst	115
2	Organizational Structures	115
3	Strategic Capability	115
4	Resource Audit (9Ms)	115
5	Competency Frameworks	116
6	Performance Appraisal	116
7	Key Performance Indicator & Critical Success Factor	116
8	Balance Score Card	116
9	Benefits & Limitations of Balance Score Card	116
10	Job Design	117

Exam Awareness

1 Roles of Business Analyst

- 1.1 Linking IT Department
- 1.2 Strategic Analysis
- 1.3 Business Process Designing
- 1.4 Business Case Development
- 1.5 Markets & Products Portfolio Analysis
- 1.6 Stakeholder Management

2 Organizational Structures

- 2.1 Entrepreneurial Structure
- 2.2 Functional Structure
- 2.3 Divisional Structures
- 2.4 Matrix Structure
- 2.5 Benefits
- 2.6 Limitations
- 2.7 Machine Bureaucracy

3 Strategic Capability

- 3.1 Competency
- 3.2 Resources

4 Resource Audit (9Ms)

- 4.1 Machinery
- 4.2 Materials
- 4.3 Money

4.4 Men & Women

4.5 Management

4.6 Methods

4.7 Make Up

4.8 Management Information

4.9 Markets

5 Competency Frameworks

7 Performance Appraisal

8 Key Performance Indicator & Critical Success Factor

8.1 Critical Success Factors (CSF)

8.2 Key Performance Indicators (KPI)

9 Balance Score Card

9.1 Financial Perspective

9.2 Customer Satisfaction Perspective

9.3 Internal Business Perspective

9.4 Innovation & Learning Perspective

10 Benefits & Limitations of Balance Score Card

11 Job Design

11.1 Scientific Management

11.2 Job Rotation

11.3 Job Enlargement

11.4 Job Enrichment

11.5 Japanese Management



Exam Topic 7:

STRATEGIC ACTION & MANAGING CHANGE

Sub Exam Topics

S.no	Headings (click the cross-ref below for easy navigation)	Pg.no
1	Elements of Strategic Change	119
2	Nature & Scope of Organizational Change	119
3	Organization Cultural Change Management	119
4	Cultural Web Paradigm	120
5	7s McKinsey Model	120
6	4 Types of Organizational Culture	120

Exam Awareness

1 Elements of Strategic Change

- 1.1 Focusing On Profitable or Core Activities
- 1.2 With Drawing from Non Profitable or Supporting Activities
- 1.3 Changing Senior Management
- 1.4 Effective Stakeholder Management
- 1.5 Financial Restructuring

2 Nature & Scope of Organizational Change

1) Nature of Change

- 1.1) Incremental change
- 1.2) Big bang change

2) Scope of change

2.1) Realignment

2.2) Transformation

- 2.1 Adaptation (Nature: Incremental/Scope: Realignment)
- 2.2 Reconstruction (Nature: Big Bang/Scope: Realignment)
- 2.3 Evolution (Nature: Incremental/Scope: Transformation)
- 2.4 Revolution

3 Organization Cultural Change Management

- 3.1 Time
- 3.2 Scope
- 3.3 Power
- 3.4 Resources
- 3.5 Capability

3.6 Readiness

3.7 Diversity

3.8 Preservation

4 Cultural Web Paradigm

4.1 Power

4.2 Stories

4.3 Routines & Rituals

4.4 Symbols

4.5 Organization Structure

4.6 Control Systems

5 7s McKinsey Model

5.1 Structure

5.2 Strategy

5.3 Systems

5.4 Staff

5.5 Style

5.6 Skills

5.7 Shared Values

6 4 Types of Organizational Culture

6.1 Power Culture (Zeus)

6.2 Role Culture (Apollo)

6.3 Task Culture (Athena)

6.4 Person Culture (Dionysus)



Exam Topic 8:
BUSINESS PROCESS CHANGE

Sub Exam Topics

S.no	Headings (click the cross-ref below for easy navigation)	Pg.no
1	Michael Porter's Value Chain Analysis	123
2	Supply Chain	123
3	Up & Down Stream Supply Chain	123
4	Organizational Process Change	124
5	Levels of Business Process Change	124
6	Process Redesign & Strategic Planning	124
7	Benefits & Limitations of Outsourcing Processes	124
8	Paul Harmon's Process Strategy Matrix	125
9	Evaluating New Software Packages	125
10	Selecting Software Package Solution	126

Exam Awareness

1 Michael Porter's Value Chain Analysis

1.1 Primary Activities (Core Activities)

1.1.1 Inbound Logistics

1.1.2 Operations

1.1.3 Outbound Logistics

1.1.4 Marketing & Sales

1.1.5 After Sales Service

1.2 Secondary Activities (Supporting Activities)

1.2.1 Procurement (purchase)

1.2.2 Firm Infrastructure

1.2.3 Technology Development

1.2.4 Human Resource

1.3 Profit

2 Supply Chain

3 Up & Down Stream Supply Chain

3.1 Upstream Supply Chain

3.1.1 Benefits

3.1.2 Limitations

3.1.3 Benefits

3.1.4 Limitations

3.1.5 Benefits

3.1.6 Limitations

3.2 Downstream Supply Chain

3.2.1 Benefits

3.2.2 Limitation

3.2.3 Benefits

3.2.4 Limitations

4 Organizational Process Change

4.1 Gaps & Disconnects

4.2 Simplification

4.3 Value Added Analysis

4.4 Re-Engineering

5 Levels of Business Process Change

5.1 Business Process Re-Engineering

5.2 Business Process Redesign

5.3 Business Process Improvement

6 Process Redesign & Strategic Planning

7 Benefits & Limitations of Outsourcing Processes

7.1 Benefits

7.1.1 Economies of Scale

7.1.2 Planning & Budgeting

7.1.3 Realization of Surplus Assets

7.1.4 Elimination of Limiting Resources

7.1.5 Flexibility

7.1.6 Experience & Expertise

7.1.7 Focus On Core Activities

7.2 Limitations

7.2.1 Loss of Control

7.2.2 Lack of Independence

7.2.3 Employees' Morale

7.2.4 Cost May Exceed Benefits.

7.2.5 Reaction of Stakeholders

7.2.6 Legislation

8 Paul Harmon's Process Strategy Matrix

8.1 Assessing Strategic Importance?

8.2 Assessing Process Complexity & Dynamics

1) Low Strategic Importance/Low Process Complexity & Dynamics

Benefit

Limitation

Benefit

Limitation

2) Low Strategic Importance/High Process Complexity & Dynamics

Benefits

8.3 High Strategic Importance/Low Process Complexity & Dynamics

Benefit

8.4 High Strategic Importance/High Process Complexity & Dynamics

9 Evaluating New Software Packages

9.1 Functional Requirements

9.2 Non Functional Requirements

- 9.3 Technical Requirements
- 9.4 Design Requirements
- 9.5 Supplier Stability Requirements
- 9.6 Supplier Reputation
- 9.7 Initial Implementation Requirements
 - 9.7.1 Data Migration & File Creation
 - 9.7.2 Software Installation
 - 9.7.3 System Implementation
- 9.8 User Training
- 9.9 Operability Requirements
- 9.10 Time and cost constraints

10 Selecting Software Package Solution

- 10.1 Obtaining Tenders
- 10.2 First Pass Selection
- 10.3 Second Pass Selection
- 10.4 Implementation
- 10.5 Managing the Long-Term Relationship

Exam Topic 9:
PROJECT MANAGEMENT

Sub Exam Topics

S.no	Headings (click the cross-ref below for easy navigation)	Pg.no
1	Project	128
2	Stages Involved In Project Management	128
3	Role or Responsibility of Project Manager	128
4	Project Management	128
5	Business Case	128
6	Benefits Realisation	129
7	Project Initiation Document (Project Charter-PMBOK)	129
8	Strategies to Address Slippage Problem	129
9	Project Planning & Management Tools	129

Exam Awareness

1 Project

2 Stages Involved In Project Management

3 Role or Responsibility of Project Manager

3.1 Outline Planning

3.2 Detailed Planning

3.3 Obtaining Resources

3.4 Teambuilding

3.5 Communication

3.6 Coordinating

3.7 Monitoring

3.8 Problem Solving

3.9 Quality Control

4 Project Management

5 Business Case

5.1 Benefits of Business Case

5.2 Contents of Business Case

5.2.1 Objective Definition

5.2.2 Scope of the Project

5.2.3 Stakeholders' Identification

5.2.4 Risk Analysis

5.2.5 Cost Benefit Analysis

5.2.6 Resource Requirements

6 Benefits Realisation

6.1 Identification & Classification of Benefits

6.2 Qualitative Benefits

6.3 Measureable Benefits

6.4 Quantifiable Benefits

6.4.1 Pilot Operations

6.4.2 External Benchmarking

6.4.3 Reference Sites

6.4.4 Modelling & Simulation

6.4.5 Internal Historical Data

6.5 Financial Benefits

6.6 Post Implementation Review

7 Project Initiation Document (Project Charter-PMBOK)

8 Strategies to Address Slippage Problem

8.1 Change in Scope

8.2 Change in Quality

8.3 Resources

8.4 Outsourcing

8.5 Rescheduling tasks

8.6 Extending Project Completion Date

8.7 Delivery in Stages

8.8 Re-negotiating Project Price

9 Project Planning & Management Tools

9.1 Critical Path Analysis/Network Analysis

9.2 Fishbone Analysis

9.3 Decision Tree

9.3.1 Uses of Decision Tree

9.4 Gantt Chart

FREE

Exam Topic 10:
FINANCE

Sub Exam Topics

S.no	Headings (click the cross-ref below for easy navigation)	Pg.no
1	Ratio Analysis	132
2	Divisional Performance Measures	133
3	Investment Appraisal Techniques	133
4	Coefficient Of Correlation	133
5	Coefficient of Determination	134
6	Forecasting Using Regression Analysis	134
7	Time Series Analysis	134

Exam Awareness

1 Ratio Analysis

1.1 Profitability ratios

1.1.1 Gross Profit Margin

1.1.2 Net/Operating Profit Margin

1.1.3 Cost of Sales Percentage

1.1.4 Operating Cost Percentage

1.1.5 Sales Growth or Decline Percentage

1.2 Working Capital or Liquidity Ratios

1.2.1 Trade Receivable Turnover

1.2.2 Inventory Turnover

1.2.3 Trade Payable Turnover

1.2.4 Current Asset Ratio

1.2.5 Quick Ratio or Acid Test Ratio

1.3 Gearing Ratios

1.3.1 Financial Gearing Ratios

1.3.1.1 Debt to Equity Ratio

1.3.1.2 Debt to Debt plus Equity Ratio

1.3.2 Operational Gearing Ratio

1.3.2.1 Contribution to Profit before Interest & Tax (PBIT)

1.3.3 Interest Cover (Times)

1.4 Investor Ratios

1.4.1 Earnings per Share (EPS)

1.4.2 Price Earnings (P/E) Ratio

1.4.3 Earnings Yield

1.4.4 Dividends Yield

1.4.5 Dividend Cover

1.4.6 Payout Ratio

1.5 Evaluating Performance using Ratios

2 Divisional Performance Measures

2.1 Return on Capital Employed (ROCE) or Return on Investment (ROI)

2.2 Calculating ROCE or ROI

2.3 Return on Equity (ROE)

2.4 Calculating ROE

2.5 Residual Income (RI)

3 Investment Appraisal Techniques

3.1 Net Present Value (NPV)

3.1.1 Performa for Calculating NPV

3.2 Benefits & Limitations of Net Present Value (NPV)

3.2.1 Benefits

3.2.2 Limitations

3.3 Internal Rate of Return (IRR)

3.4 Benefits & Limitations of Internal Rate of Return (IRR)

3.4.1 Benefits

3.4.2 Limitations

3.5 Discounted Payback Period

4 Coefficient Of Correlation

5 Coefficient of Determination

6 Forecasting Using Regression Analysis

6.1 Assumptions of Regression Line Analysis

6.2 Advantages & Disadvantages of Regression Line Analysis

7 Time Series Analysis

7.1 Trend

7.2 Seasonal Variations

7.3 Cyclical Variations

7.4 Random Variations

RELATED PRODUCTS

Books	Free Demo
Management Accounting	<u>F2</u>
Performance Management	<u>F5</u>
Financial Management	<u>F9</u>
Governance, Risk & Ethics	<u>P1</u>
Business Analysis	<u>P3</u>
Ebusiness/Ecommerce/Make Money Online	<u>\$£€</u>

Click the hyperlinks above in underlined style to visit relevant webpage at <http://accasupport.com>

Buy Full ACCA P3 Study Text Book (250±) at ACCASUPPORT.COM | [FB GROUP](#) | [COMMENT](#) | [FORUMS](#) | [JOBS](#)
ACCA F2, F5, F9, P1 Study Materials Free Download & ACCA Distance Learning Course & Classes in Karachi



REPORT ABUSE

Please inform me at kabuli_52@hotmail.com (preferred) or murtaza@accasupport.com, if you find any misuse of this study material or www.accasupport.com. In addition, if you find any information in this study material or website that is awkward, unethical, other than normal etc from your viewpoint.

This study material is not available at any other website over the internet except clickbank.com. In addition, this study material is not available in the form of printed books, DVDs etc.

Website hacking is very common over the internet. Hackers modify, delete and add contents on the targeted websites by gaining unauthorized access to webserver, where the webpages are stored.

Reporting abuse will save other visitors to the website from being victimized. Please help me discouraging these anti-social elements.

I will keep confidential any corresponding between us.

For more info, please see my [privacy policy](#)

ACCA no... F1
Ebook P... F4 BWA, CHN, CY...
Book... LSO, MLA, MYS...
CZ... SGP, VNM, ZAF and ZI...
F5
Text... CHN, CY, CZ...
Class... O, MWI...
Study Te... S, S...
Book 4 E...
Lea...
ACCA...
download...
Exam Kits
Revision Kit
Pocket notes
Passcards
notes