

# ACCA P1 EBOOK DEC 2012

## EXAM TOPICS

---

*Note: click the cross-reference below for easy navigation. Click  or press Ctrl + Home to come back.*

EXAM TOPICS .....	1
KEY TERMS.....	3
INTENDED BENEFITS OF THE E-BOOK.....	6
AUTHOR'S PROFILE .....	19
IMPORTANT!.....	20
USER GUIDE .....	22
INTRODUCTION TO P1 GOVERNANCE, RISK & ETHICS .....	24
EXAMINER'S GUIDANCE .....	27
AUTHOR'S GUIDANCE .....	33
SOLVING SCENARIO BASED QUESTIONS .....	34
PAST EXAM PAPERS' ANALYSIS .....	35
STUDY PLANNER .....	39
Exam Topic 1: WAYS TO RESPOND TO ETHICAL DILEMMAS.....	42
Exam Topic 2: CORPORATE SOCIAL RESPONSIBILITY& ETHICAL STANCES.....	57
Exam Topic 3: PROFESSIONAL'S PRACTICE & CODES OF ETHICS.....	64
Exam Topic 4: THREATS TO ETHICS & SAFEGUARDS .....	66
Exam Topic 5: SOCIAL & ENVIRONMENTAL ISSUES .....	68
Exam Topic 6: NEED FOR CORPORATE GOVERNANCE .....	71
Exam Topic 7: BASICS OF CORPORATE GOVERNANCE .....	74
Exam Topic 8: ROLES OF CEO, CHAIRMAN, & NEDs .....	76
Exam Topic 9: OTHER IMPORTANT STAKEHOLDERS .....	79
Exam Topic 10: STAKEHOLDERS IDENTIFICATION & MANAGEMENT .....	81
Exam Topic 11: NOMINATION & REMUNERATION COMMITTEES.....	84
Exam Topic 13: GOVERNANCE SYSTEM & STRUCTURES.....	87
Exam Topic 14: RULES & PRINCIPLES OF GOVERNANCE .....	89

Exam Topic 15: INTERNAL CONTROL & RISK MANAGEMENT FRAMEWORK.....	92
Exam Topic 16: BEST PRACTICE FOR INTERNAL CONTROL & RISK MANAGEMENT.....	94
Exam Topic 17: RISK IDENTIFICATION .....	96
Exam Topic 18: RISK ASSESSMENT, RESPONSE & CONTROL ACTIVITY.....	99
Exam Topic 19: INFORMATION & COMMUNICATION & MONITORING.....	101
Exam Topic 20: AUDIT COMMITTEE AND INTERNAL AUDIT DEPARTMENT .....	104
Exam Topic 21: ROLES OF RISK MANAGEMENT COMMITTEE & DEPARTMENT .....	106
RELATED PRODUCTS .....	108
FREE BLOGS.....	109
REPORT ABUSE.....	110

[BE AN AFFILIATE](#)

[BE A PARTNER](#)

**ACCA EXAM FOCUSED STUDY TEXT BOOKS FREE DOWNLOAD**

**Special Offer**

Place a <http://accasupport.com> link at any ONE of your    or other account to get any TWO exam topics above of your choice for free not included in free version by emailing at [kabuli\\_52@hotmail.com](mailto:kabuli_52@hotmail.com) or [murtaza@accasupport.com](mailto:murtaza@accasupport.com)

Email should contain web page URL where you have placed a link and name of any TWO exam topics you want.

## KEY TERMS

---

---

### A

Absolutism · 42  
Accountability · 72  
Accurate · 99  
Advocacy Threat · 64  
Agency Cost · 69  
Agency Problem · 69  
Agency Theory · 69  
American Accounting Association  
(AAA) Model · 50  
Annual General Meeting · 68, 69  
Arithmetical And Accounting · 97  
Audit Committee · 102  
Authoritative · 99  
Authorization And Approval · 97

---

### B

Basic Pay · 69  
Benefits · 70  
Board · 87  
Bonus · 69  
Business Risk · 94

---

### C

Catastrophe Risk · 95  
CEO · 74  
Chairman · 74  
Chairman's Statement · 74  
Codes Of Corporate Governance ·  
87

Collusion Between Employees · 99  
Committees · 87  
Complete · 99  
Compulsory Redundancy · 82  
Confidentiality · 62  
Consequentialist · 39, 43  
Control Activities Or Procedures · 97  
Control Environment · 90  
Conventional Moral Development ·  
46  
Corporate Citizenship · 55  
Corporate Social Responsibility · 55  
COSO Framework · 89, 90  
Cost Beneficial · 99  
Cost Benefit Considerations · 99  
Credit Risk · 95  
Cross Directorship · 81, 83  
Customer Risk · 95

---

### D

Data Protection Risk · 95  
Deep Ecologists · 60  
Downward Communication · 99

---

### E

Easy To Use · 99  
Economic Exposure Risk · 95  
Economic Responsibility · 55  
Egoism · 44  
Entrepreneurial Risk · 94  
Environmental Auditing · 66

Environmental Risk · 95  
Equivalent View · 56  
Event Identification · 90  
Expedients · 58  
Extended View · 57  
External Auditor · 102  
Externalities · 66  
Extra Ordinary General Meeting  
(EGM) · 69

---

**F**

Fairness · 72  
Familiarity Threat · 64  
Fiduciary Duties · 69  
Financial Reporting Risk · 95  
Foreign Exchange Risk · 95  
Fraud Risk · 95  
Fundamental Risk · 94

---

**H**

Hacker Risk · 95  
Honesty/Probity · 72  
Human Error · 99  
Human Resource Risk · 95

---

**I**

Impact (Hazard) · 94  
Independence · 72  
Independence Of Internal Audit  
Function · 102  
Induction Programme · 82  
Information & Communication · 90  
Information Technology Risk · 95

Insider Dealing · 64  
Integrity · 72  
Intellectual Property Risk · 95  
Interest Rate Risk · 94  
Internal Audit · 102  
Internal Audit Function · 102  
Internal Audit Testing · 102  
Internal Control · 87

---

**J**

Judgement · 72

---

**K**

Kant's Categorical Imperatives · 44  
Kohlberg's Cognitive Moral  
Development · 39, 45

---

**L**

Legal Responsibility · 55  
Legal Risk · 95  
Limited View · 56  
Liquidity Risk · 95

---

**M**

Management · 97  
Management Circumvention Of  
Control · 99  
Market Risk · 94  
Monitoring · 90  
Multi Tier · 84, 85

---

**N**

Negative Footprint · 66  
Nomination Committee · 82  
Non Business Risk · 94  
Non Executive Directors · 74

---

**O**

Objective Setting · 90  
Objectivity · 62  
Openness/Transparency · 72  
Operational Risk · 94  
Organization · 97  
Outsourcing Risk Management · 104

---

**P**

Particular Risk · 94  
Pension · 70  
Performance Related Reward  
Schemes · 70  
Personnel · 97  
Philanthropic Responsibility · 55  
Physical Control · 97  
Political Risk · 95  
Positive Footprint · 66  
Post Conventional Moral  
Development · 47  
Pre-Conventional Moral  
Development · 46  
Pristine Capitalist · 58  
Private Vs Public Sector Governance  
· 87  
Probability · 94  
Professional Behaviour · 62

Professional Competence · 62  
Profit Related Pay · 70  
Public Interest · 62  
Pure Risk · 94

---

**R**

Radical Feminists · 60  
Relativism · 42  
Reliable · 99  
Remuneration Committee · 83  
Reputation · 72  
Reputation Risk · 95  
Responsibility · 72  
Retirement By Rotation · 82  
Risk Appetite · 94  
Risk Assessment · 90, 97  
Risk Attitude · 94  
Risk Capacity · 94  
Risk Embedding · 92  
Risk Management Committee · 104  
Risk Management Department · 104  
Risk Management System · 89, 90  
Risk Manager · 103, 104

---

**S**

Segregation Of Duties · 97  
Self Interest Threat · 64  
Self Review Threat · 64  
Share Options · 70  
Social & Cultural Risk · 95  
Social & Environmental Footprint ·  
66  
Social Contract · 58  
Social Ecologist · 59

Social Responsibility Stances  
(Positions) · 57  
Socialists · 60  
Speculative Risk · 94  
Stakeholders · 78, 79  
Stock Holder · 58, 78, 79  
Strategic Risk · 94  
Strong Vs Weak Sustainability · 66  
Supervision · 97  
Sustainability · 66

---

**T**

Tara Framework · 96, 97  
Technological Risk · 95  
Teleological · 39, 43  
Timely · 99

Transaction Cost Theory · 69  
Transaction Risk · 95  
Translation Risk · 95  
Tuckers 5 Step Model · 48

---

**U**

Uncertainty · 94  
Unitary · 84, 85  
Upward Communication · 99  
User Targeted · 99  
Utilitarianism · 43

---

**V**

Voluntary Redundancy · 82

# INTENDED BENEFITS OF THE E-BOOK

---

## Features &

## Benefits of ACCA Study Text Ebook

### 1) **Exam Focused:**

**Exam focused ACCA study text ebooks** are aimed to help you passing exams by allowing you spend **efforts and time smartly**.

ACCA study text books aim to educate you in the way you are **expected to apply** your knowledge in the exam.

ACCA study text books are **updated** prior to each exam session and during the exam session in the light of recent information available such as examiner published an article in student accountant. In that case, you will **receive updated version** of relevant ACCA study text book via e-mail.

[accasupport.com](http://accasupport.com)

Usually **ACCA** students look for **ACCA exam tips** at the end of exam session to learn important syllabus areas much better. Therefore, those ACCA students usually do exam focused study only 2 weeks or 1 month before. ACCA students can greatly improve the probability of **passing exams** if they do exam focused study from the beginning.

### **Exam Focused ACCA Study Text Books**

bring all relevant information under one roof to eliminate information gathering on relevant ACCA

exam paper and prevents the chances of omission of important information about the relevant ACCA exam paper.

**These study materials take account of examiners comments and reports, past exam papers, student accountant articles, tips from other tutors, syllabus areas examined by other professional accountancy bodies, publications in business magazines etc.**

---

**2) Examiner's Guidance:**

**Examiner's Guidance** are **exam preparation tips** given by the examiner in **student accountant, examiner's interview** and other documents.

---

**3) Author's Guidance:**

Author's guidance are **applicable to all syllabus areas**.

It also includes tips to enable you to **prepare for exams** and **perform during exams** effectively .

---

**4) Exam Awareness:**

Exam Awareness shows the **frequency and magnitude** (marks) of each syllabus area.

It also shows the **relationship** between various syllabus areas and how each syllabus area **contributes** toward passing exams.

---

**5) Exam Support:**

Exam Support provides guidance on **application of knowledge** in exam context.

Just knowledge is not enough for passing exams rather you have to use it wisely in limited time available in the exams.

---



6) **Past Paper Analysis (F5, F9, P1, P3):** Past paper analysis is given at the **beginning** of the study text and also **directly below** relevant headings.

Past paper analysis at the beginning of the study text enables you to practice past exam questions relevant to each **syllabus area on ACCA global website**. Therefore, you **do not need to buy** expensive **practice kit** or search for relevant questions to practice a particular syllabus area.

**Past paper analysis** directly below each relevant heading gives an **idea** about the length, complexity of requirements and VERBS (Explain, Evaluate, Report etc) in which each syllabus area can be examined.

---

7) **Learning Objective (F2/FMA only):** Learning objective sets the **knowledge and skills expected** to be achieved after reading particular syllabus area.

**F2 Management Accounting** exam format does not provide significant benefit from past paper analysis. In **CBE (computer based exams)** each candidate may be examined different set of **questions**.

However, importance of each exam topic is discussed under exam awareness and exam support headings.

---

8) **Illustrations (if any):** Illustrations are **simple numerical examples** given to prepare students for more challenging exam standard questions.

---

Illustrations depend on the **type of ACCA paper**. Discussion based ACCA papers may not include illustrations.

---

**9) Explanations (if any):** Explanations are given to explain the **rationale** (why & how) behind steps involved in calculations.

Explanations depend on illustrations provided in the **study text book**.

---

**10) Examples:** Examples are given to explain technical theoretical knowledge in **simple and understandable way**.

Technical jargons are used to prepare you for different technical terms used by the examiner to **dodge you** to ensure that you understood the text rather than rote learn the text.

These technical jargons are explained in parenthesis or as separate example to make you understand the technical term and syllabus area as whole.

It also shows the **application of knowledge** into practice.

It is especially useful when you are **expected to apply** your knowledge to answer scenario based questions.

Processing information meaningfully and logically leads to better retention of information. Linking new information to information already

---

committed to your memory, such as every day experiences, is proven technique for learning new knowledge.

It will also **motivate** you to learn harder, as you will understand the benefits of technical knowledge **in your career** as chartered accountant.

---

### 11) **Diagrams:**

Diagrams are given to explain **complex concepts and procedures**, which are difficult to understand in words.

Diagrams also lead to better **memorization** of knowledge.

Diagrams lead to the use of **right brain** while text lead to the use of **left brain**. Combination of text and diagrams enables you to learn ACCA papers using both brains to avoid getting overstressed left part of the brain due to excessive reading.

Left brain is responsible for reading, calculation, analysis. Right brain is responsible for establishing relationships, reading graphs & charts and dealing with non-financial aspects, such as motivation of managers and employees.

---

### 12) **Practice Questions:**

**Practice questions** are **exam standard questions** to provide a clue about length complexity and format of questions likely to be asked in the exams.

Solutions are given in a format that will **save time**, while solving questions during the exams.



Time management is important during exam, ability to solve question but taking more than time available is of no use. You must be able to solve question within given time. Therefore, you must identify, which steps will be rewarded and which steps can be omitted without losing marks.

In addition, you solution should be properly cross-referenced such as working 1, 2, 3 etc and labeled using descriptive text rather than abbreviations.

Solution is supported with explanations to tell you why and how that particular step is performed.

---

### 13) **Hyperlinks:**

Hyperlinks are **links** to other areas of study text book. In addition, **table of exam topics** are linked  to **exam topics** and **table of sub exam topics** are linked  to **sub exam topics** given at the beginning of each exam topic.

Hyperlinks will save several minutes per day, which you may spend navigating through ordinary printed and ebooks. Hyperlinks will save large amount of time during the whole exam session.

---

### 14) **Bookmarks:**

**Bookmarks** are given for reaching **quickly** to relevant **syllabus area**. It is an alternative to hyperlinks.

---

### 15) **Key Terms:**

Table of key terms shows **important terms** across the study text book that you must understand in order to learn relevant topic and pass the exams.

It allows you to reach to the place inside study text book, where you can develop **basic understanding** about particular term.

---

**16) Colours:**

Colours are used for **demarcation** between essential text, supporting examples, exam support etc.

It will enable you to **find** required ebook feature such as example, exam support, diagram etc easily.

It also make learning **interesting**. Writing golden words without motivating reader to read it is of little use.

---

**17) Annotations:**

You can highlight text and add comment anywhere in the study text book.

Highlighting will enable you to **highlight phrases** and sentences you want to read again.

Commenting will allow you to make a **brief note** in the study text book. You can use commenting to:

- **Save** mnemonics.
- **Mark** as read important, unread, read, Revised etc.

However, most publishers do not allow these features to enforce their copyrights.

---

**18) Readout Loud:**

Readout load enables students to **listen** written text. You can use any screen reader of your choice

---

to convert text to speech.

Those who have **problem reading text** can particularly benefit from this feature.

Others can have a **break from reading** text.

Listening involves the use of Right brain opposed reading, which involves the use of Left brain.

Listening allows your Left brain to revitalize for future reading.

It will also help **revision** of your syllabus before exams much faster. It is usually believed that listening is many times faster process than reading. You can adjust the speed according to your preference.

Each point of theory is started from separate line to enable you to listen only the **text of your interest**.

---

#### 19) **Accessibility:**

These study text books have **legible fonts type & size and high contrast** colours to enable you read easily without producing strain on your eyes.

You do not need to zoom and then scroll horizontally  to read study text.

You can switch to two pages per screen layout to avoid frequent vertical scrolling, without compromising readability to significant extent.

---

#### 20) **Study Planner:**

Study planner is a method allows you to **plan for study** within limited time available.

It also allows you to **track your progress** against plan; therefore, you can adjust your speed

---

of study and study hours accordingly.

Time management is specially important for professional students that you have to meet other commitment such as job, friends and family.

---

**21) Printer Friendly:** ACCA study text books are **economical** to print.

Diagrams, tables and other formatting are made to keep the cost of printing to minimum.

You may consider printing two pages side by side to save papers and cost, without compromising readability to significant extent.

Most other publishers do not allow printing an ebook at all or just allow to printed 25% - 60% of the ebook pages. accasupport.com allows 100% printing of the ebook pages.

It will also provide **portability** as you can easily carry it in our bags.

---

**22) PDF File Format:** PDF (Portable document format) files can be viewed using **free adobe reader**.

Adobe reader is compatible with most operating systems such as **windows, Mac, Android etc.**

You can also read ACCA study text ebook on **tablets and cell phones** supporting PDF format to take these ebooks **on the way or at workplace** in your pocket.

Therefore, you also **do not need** to buy pocket

notes too.

It can be used on multiple computers and mobile device without any limitation imposed on the number of devices.

PDF file format is widely used file format used to compress file size of electronic documents such as ebooks and takes very little time to load as compare to ebooks having EXE file format.

ACCA study text ebook is searchable through any software having find and replace function.

However, conversion of PDF into **DOC, TXT** etc format may distort structure of an ebook or make it unreadable at all.

---

**23) Environment Friendly:**

Reading Ebooks on digital media such as **PC, laptop, tablets, cell phones** are among the best ways to save papers and therefore, environment from greenhouse effect.

Millions of papers can **save** thousands of **trees each day**.

It also prevents **CO<sub>2</sub> emission** in traveling or delivery of printed books in addition to traveling or delivery cost and time.

In addition, it is our **moral duty to care** for environment and society who lives in that environment.

---

**24) Instant Download:**

You can benefit from **studying immediately** after download. Step-by-step guidance is given for downloading ebook for first time buyers.

---



One step secured order form without any registration. All major credit cards & paypal accepted.

No installation required of custom software design to enforce copyrights. Custom software may not work well with different PCs, laptops, mobile devices etc, as it is virtually impossible to test custom software against different hardware and software specifications.

Some anti-virus softwares prevent unpopular softwares from running on the system. Therefore, you may need to disable anti-virus prior to executing the application.

PDF file format is widely used file format for sharing documents online and offline. Therefore, it is very unlikely to have issues with PDF file. There are numerous free PDF readers available to suit your needs.

No licensing and online registration requirements.

No waiting time for receiving password or ebook itself.

Please! Note that ebook cannot be refunded due to instant download and no DRM (Digital Rights Management) protection software imposed, as others.

---

---

**25) Guaranteed Pass:** You will be granted 100% **free study text ebook** for subsequent exam session until you pass your exams.

**(nothing to lose)**

Unfortunately, if an **ACCA student** does not make a pass, then he/she has to send an e-mail along with **ACCA result** screen shot/**PDF** file and customer order number or transaction identification number.

---

**26) Harmony** Most publishers do not involved writing and editing their books. They hire writers having expert knowledge on particular topic. However, they are not connected with ACCA training provision and therefore, not aware of practical challenges, jargons etc faced by students during the exams and areas of weakness on the part of students.

It creates lack of harmony between different syllabus areas. Each syllabus area seems to be unrelated to each other while studying. However, most examiners require students to demonstrate the understanding of overlapping nature of the syllabus. This would not be a case, if entire syllabus of relevant ebook was written by one mentor.

---

**27) Core Activity** Many publishers using their study text books as marketing tool for other highly profitable activities such as tuition providing, recruitment agency, paid advertising etc. Ebook publishing is not their core competency. They tend to direct their resources towards more profitable activities, while quality of ebooks may suffer as a result.

accasupport.com is devoted full time to ebook publishing and continuously acquire new skills (memory techniques, for example) and resources (word processing software, for example) to compile an ebook to support students in much better way.

---

**28) Direct Access**

You will have direct access to author & administrator, without having to wait for information to be transfer to and from more than one desk to reach the person responsible for making decision. It will result in quicker response to inquiries. In addition, you need to send only single email to resolve your all issues rather than dealing with different personnel for each issue, regarding purchasing and usage of ebooks.

---

**29) No Hidden Policies**

Many publishers provide money back guarantees and gifts etc. However, it is subject to hidden charges and conditions, which are not communicated on sales page and ebook description page. Instead, such policies are communicated on FAQs, Terms of Service, Delivery etc pages.

accasupport.com has no such hidden polices. Refund policy is communicated at the bottom of home page and instant download feature.

---

## AUTHOR'S PROFILE

---

**Name:** Murtaza Lanewala

**Career Status:**

Freelance writer & tutor for professional accountancy qualifications. Professional bodies include ACCA, CIMA and ICAEW.

Author & CEO of [accasupport.com](http://accasupport.com)

**E-mail:**

[kabuli\\_52@hotmail.com](mailto:kabuli_52@hotmail.com) or  
[murtaza@accasupport.com](mailto:murtaza@accasupport.com)



# IMPORTANT!

---

## 1 Disclaimer

This study material is sold only through [accasupport.com](http://accasupport.com) website. However, Clickbank.com is the credit card processing organization for collecting payments for this study material. This study material **is not available offline (shops, schools etc.)** in any form such as DVDs, CDs, Printed books etc. Study materials purchased from unauthorized source can be out of date and incomplete. In addition, you will not be able to receive **free updates** given to the buyers of original material.

Demo version of this material is available free of cost, please take care, not to pay for demo version of this e-book to authorized sellers.

This material is for ACCA examination **Dec 2012 only**. Students who are reading out-dated material are at risk, as it will not be representative of current examination format, terminologies and syllabus.

Readers of this material will be solely responsible for the consequences of any decisions made in real life. Author & [accasupport.com](http://accasupport.com) are not responsible to the readers of this material under any circumstances.

Recommendations made of any kind are intelligent guesses to the best of author's knowledge.

## 2 Copyright Notice

This material is subject to copyright protection law. Infringement of copyright law results in criminal liability (fine or imprisonment or both).

Copyright infringement is effectively theft of intellectual property; therefore, it is unethical from social viewpoint and sinful act from religious viewpoint as well.

Copyright ©2012 Murtaza Lanewala. All rights reserved.

### 2.1 Do

You can make a backup copy of this material.

You can use parts of this material provided you quote the appropriate reference to the author and material.

## 2.2 Do Not

You cannot publicly share this material in the form of hard copy or soft copy (physically and over the internet) for cash or for free.

You cannot transform this material into other means of communication such as photocopy, video, audio etc. Unless needed for accessibility purpose or personal use.

You cannot change the file format of this material or make it editable.



You cannot resell this material unless you are selling the original copy purchased.

You cannot use any part of this material in or with contents associated with violence, politics, religious and pornographic contents in any way.

[BE AN AFFILIATE](#)

[BE A PARTNER](#)

## USER GUIDE

E book features	Details
Past Papers	Past papers provide a clue about the verbs (Explain, Evaluate etc.) and marks available in the exams.
Sub Exam Topics	It provides list of main headings at the beginning of each exam topic. You have to click relevant heading in a list to reach there.
<i>Exam Topic Awareness</i>	It provides broad information on composition (theoretical v computational) and importance of each paper in exam context.
<i>Exam Support</i>	Exam Support provides detailed information on application of theory and calculations in exam context.
<i>Example</i>	Example provides practical application of technical theoretical knowledge.
Illustration (If any)	Illustration provides numerical applications of theoretical knowledge.
Explanation (If any)	Explanation provides the reasons for correctness or un correctness of particular statements and calculation.
<i>Formula (if any)</i>	Formula is mathematical equation or tabular format.
Diagram	Diagrams are visual (Graph, Charts, Tree formats etc.) presentations of theoretical knowledge.
Cross reference	Cross-referencing are hyperlinks to other exam topics. Click previous view button   to go back or Alt + Left Arrow Key.
Highlighting	Highlighting is used show the relationship between words and figures.
Bookmarks 	Click bookmark icon in the side bar (see below) to jump to specific exam topic in the e-book.

Screen Shot:

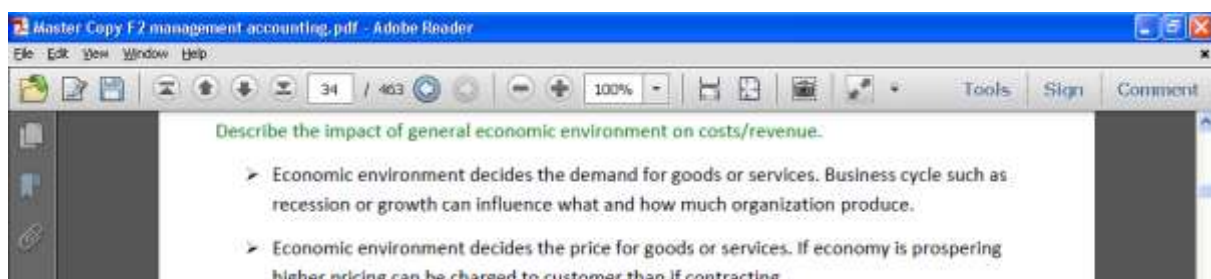

If you not currently using adobe reader, then I recommend you to download adobe reader, to get most benefits from this e-book. Click <http://get.adobe.com/reader/> to download.



# INTRODUCTION TO P1 GOVERNANCE, RISK & ETHICS

---

1 Examiner

**David Campbell**

2 Aim

To apply relevant knowledge, skills and exercise professional judgement in carrying out the role of the accountant relating to governance, [internal control](#)<sup>92</sup>, compliance and the management of risk within an organisation, in the context of an overall ethical framework.

3 Assumed Knowledge from Previous Papers

You are expected to have knowledge from following papers for the purpose of this exam.

F1 Accountant in Business.

F8 Audit & Assurance.

4 Position of P1 Governance, Risk & Ethics in ACCA

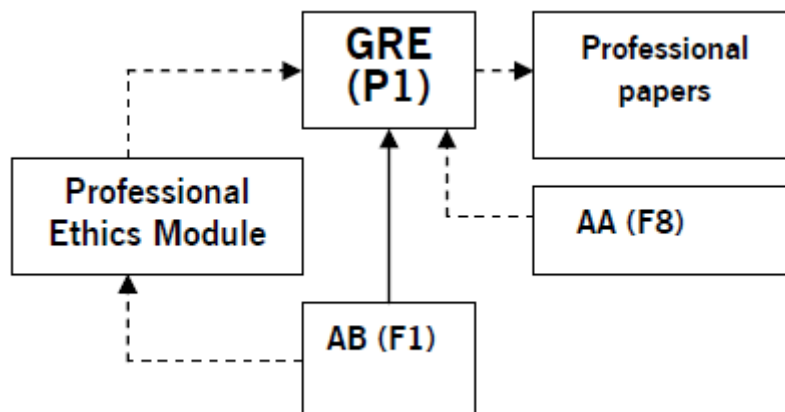

### Exam Support:

*Syllabus areas that are not included in the study guide of previous papers are more likely to be examined in P1 Governance, risk & ethics than those that are already included in pervious papers.*

## 5 Main Capabilities & Relationships

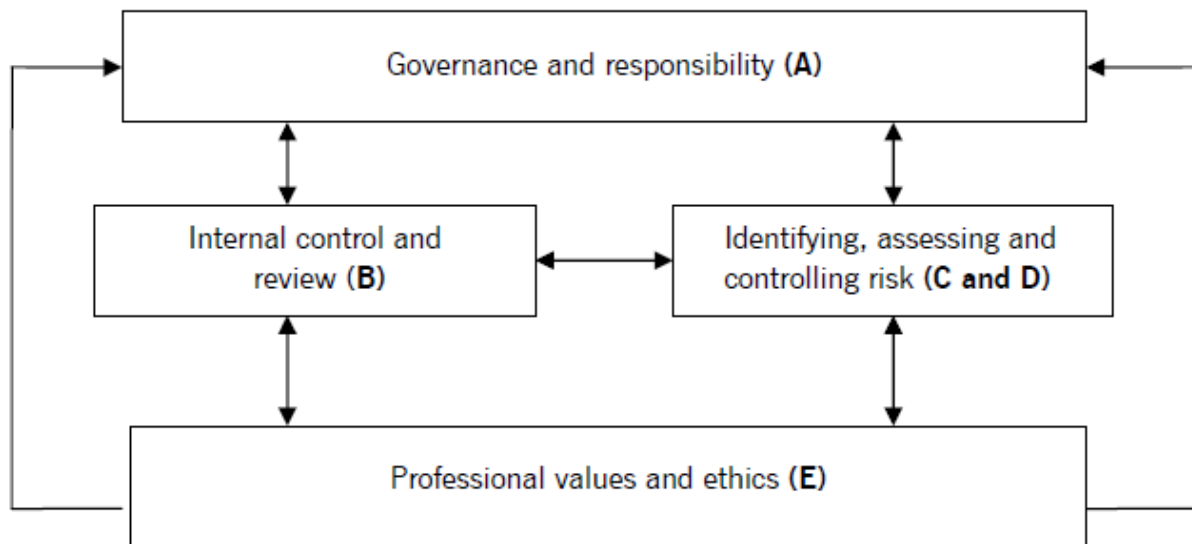

## 6 Exam Paper Format

Section A contains 1 compulsory question for 50 marks inclusive of 4 professional marks for rewarding communication and presentation skills.

Section B contains 3 questions for 25 marks, out of which you can choose any 2 questions.

Questions could be comprised of many requirements (a, b, c, d etc).

P1 Governance, Risk & Ethics is 99% discussion based paper. However, memorizing text will not help you passing the exam rather you should be able to apply your knowledge to scenario-based questions. Information provided in the scenarios is taken from real world.

## 7 Duration of Exam

Total time: 3 hours 15 minutes

3 hours are writing and reading time.

Additional 15 minutes are reading and planning time. However, you can annotate question paper only during that time.

8 Resources:

<http://www.accaglobal.com/en/student/qualification-resources/acca-qualification/acca-exams/p1-exams.html>

<http://www.accaglobal.com/en/student/Essentials/pass-exams.html>

<http://updates.accasupport.com>

<http://accasupport.com/blogs.htm>

# EXAMINER'S GUIDANCE

---

By **David Campbell**

22 Feb 2007

Paper P1, *Governance, Risk and Ethics* is a new compulsory paper in the Essentials module at the Professional level of the ACCA Qualification. It is an exciting, challenging, and innovative paper that aims to enrich students' understanding of a number of important issues as they prepare to take their place as members of the professional accounting community.

Following in-depth consultation on the development of the new ACCA Qualification, and guidance on ethics and governance teaching from IFAC and others, it was decided to create a new paper to examine a number of areas relevant to the broad themes of professionalism, responsibility, accountability, and ethics. In terms of syllabus content, these themes are handled in the context of [corporate governance](#)<sup>72</sup>, [internal control](#)<sup>92</sup>, risk, and professional and business ethics. These areas form the basis of the new Paper P1 syllabus.

Content from a number of other parts of the new ACCA Qualification is relevant to the Paper P1 syllabus (refer to the 'linked papers' diagram in the *Syllabus*). Most obviously, it forms a prominent part of the qualification's emphasis on ethics. Professionalism and ethics are both at the heart of the new ACCA Qualification. They are covered in 11 of the 16 exam papers - including all papers at Professional level - and three of the Essentials performance objectives as part of the practical experience requirement. Underpinning the syllabus and the practical experience is the Professional Ethics module. The aim of the Professional Ethics module is to give students exposure to a range of ethical perspectives and can be completed once eligible to take Paper P1. Ideally, the Professional Ethics module should be taken at the same time as - or soon after - completing Paper P1. In addition, the Paper P1 syllabus builds on and develops content studied previously in Paper F1, *Accountant in Business* and Paper F8, *Audit and Assurance*.

It is important to study an ACCA-approved textbook for Paper P1. They are written especially for the syllabus, and are reviewed by the examiner, making them invaluable in terms of coverage and insight into what is examinable. The syllabus for Paper P1, possibly more than any of the other papers, is eclectic in nature and draws on material from a number of different disciplines. Students are strongly encouraged to read around the subject area, especially those students new to the content of the syllabus. A number of recommended books are listed at the end of the *Study Guide*.

## Syllabus and relational diagram

Although the syllabus contains five areas (refer to the 'relational diagram' in the *Syllabus*), it is important to understand that all of these, taken together, comprise a logical 'whole'. All areas are interconnected and, in total, the syllabus represents a set of issues essential to the understanding of how accounting - especially in a business context - contributes to, and is underpinned by, governance and ethics. Although these have always been important to the accountancy profession, a number of well-publicised recent corporate failures and scandals have highlighted the need for sound governance and ethical behaviour. Society invests a great deal of trust in its professions and it is crucial that accounting professionals repay that trust and maintain the level of respect and regard in which they have been traditionally held. Accordingly, accountants need to be aware of their responsibilities to investors, to society, and to the highest standards of professional probity and competence. The content of the Paper P1 syllabus will help students explore and develop these themes.

Part A of the syllabus focuses on [corporate governance](#)<sup>72</sup>, responsibility, and accountability. This means exploring aspects of, for example, the [Agency](#)<sup>69</sup> relationship between directors and shareholders, the meaning of governance, the role and types of directors, issues of responsibility, and the meaning and limits of accountability. It aims to introduce these important themes while also encouraging students to think about the ethical assumptions made by accountants collectively as a profession.

The next three parts of the syllabus - B, C and D - focus specifically on issues that have, in recent corporate failures, been the most problematic. These include internal control, the identification and assessment of risk, and controlling and mitigating risk. The Paper P1 syllabus singles these out for separate consideration because, although they are integral to Corporate Governance Definition [corporate governance](#)<sup>72</sup> as a whole, they play a crucial part in an accountant's responsibility to act in the [Public Interest](#)<sup>62</sup> Public Interest and in the interests of shareholders.

Sound systems of internal analysis, control, and audit underpin all effective [corporate governance](#)<sup>72</sup> systems. Effective management at the strategic level rests on the assumption that internal activities can be controlled, verified, and reported on internally. If management loses control of internal systems and procedures, any claim of sound governance is lost – as was the case at Baring's Bank, when a single uncontrolled trader lost large amounts of money on derivatives markets. The same is true of risk. Being aware of all possible risks, understanding their potential [impact](#)<sup>94</sup>, as well as the [Probability](#)<sup>94</sup> of occurrence, are important safeguards for investors and other [stakeholders](#)<sup>79</sup>

All of these preceding sections are underpinned by Paper P1's important consideration of both professional and business ethics - Part E of the syllabus. Ethical assumptions underpin and 'surround' any profession and system of governance. The accountancy profession, just as in medicine or law, is governed by certain ethical frameworks that inform practice and guide practitioners. This part of the Paper P1 syllabus explores some of these assumptions, while also looking at some of the ethical theories that help to explain them. This part of the syllabus will always be assessed to some degree in the compulsory section of the exam, but not necessarily exclusively in that section.

## **Study Guide and intellectual levels**

The *Study Guide*, which breaks the syllabus down into separate sections, is on the ACCA website. The superscript numbers at the end of each objective in the *Study Guide* indicate the level at which students should understand a particular subject or topic area. These levels of understanding, known as cognitive levels, are important as they indicate the depth to which each part of the syllabus may be examined.

Because Paper P1 is at the Professional level, the higher cognitive challenges - represented by the number 3 - are prominent. This means that this paper is more likely to use higher levels of questioning; whereas level 1 task might concern knowledge and comprehension (such as 'list', 'define', 'identify', 'calculate'), levels 2 and 3 are more challenging. Level 2 tasks concern application and analysis ('contrast', 'explain', 'discuss', and so on), and level 3 tasks concern synthesis and evaluation. Level 3 requirements might therefore include 'construct', 'evaluate', 'assess', 'formulate', or 'advise'.

It is likely that each Paper P1 exam will contain several questions at levels 2 and 3, and the *Study Guide* reflects this emphasis on higher cognitive levels. It is important to realise that if *Study Guide* sections require learning at levels 2 or 3, then it is possible that the exam will test that area at that cognitive level. The marking scheme will reflect this, and answers that do not attempt to answer at the higher cognitive level will be rewarded accordingly. If, therefore, a question asks a candidate to 'assess' or 'evaluate' an argument or a statement, answers that merely 'describe' will not be well rewarded.

### **Ethical and governance codes**

Paper P1 covers two areas that, in some countries, are underpinned by 'codes' or 'guidelines' that attempt to regulate practice. In the light of recent [corporate governance](#)<sup>72</sup> failures, governments and professional bodies have introduced these codes so as to reduce the 'freedom of movement' for managers, and to make their duties and responsibilities unambiguous in certain circumstances. The UK was among the first to introduce such initiatives, with the Cadbury Code back in 1992, but the intervening years have seen many other codes springing up in different parts of the world. Some apply to single jurisdictions, such as in Singapore, the UK, and the US, while other codes are intended to apply internationally. IFAC's and ACCA's Codes of Ethics are examples of ethical codes, while the Organisation for Economic Co-operation and Development (OECD) and International [corporate governance](#)<sup>72</sup> Network (ICGN) both have international codes of corporate governance.

In the Paper P1 *Study Guide*, I have highlighted the fact that whereas a general knowledge of codes is important, line-by-line detail is not required. While the UK codes (such as the Combined Code, first published in 2003) provide a good summary of provisions in corporate governance, other countries and agencies have also produced equivalent guidelines. Students may be required to demonstrate familiarity with a code when answering a question, but it will be acceptable to refer to a local code if more appropriate, or to one of the international codes. ACCA's Code of Ethics applies broadly, and IFAC's Code of Ethics applies to all professional accountants whose professional bodies are members of IFAC (such as ACCA). If students live in a jurisdiction with its own code of ethics (such as the ICPAS code in Singapore), it will be acceptable to refer to that code where appropriate.

Explicit reference is made in the *Study Guide* to Sarbanes-Oxley, which is the legal underpinning of [corporate governance](#)<sup>72</sup> in the US. Sarbanes-Oxley is the most influential corporate governance instrument of recent times and has changed practice globally, mainly because of the international dominance of US business.

### **Exam format**

The exam will contain two sections. Section A will contain Question 1, which will be worth a total of 50 marks and which will be compulsory. It will be based on a case study scenario of several hundred words. The requirements will include several distinct tasks (listed as (a), (b), (c), etc.) and will sample the syllabus quite broadly. Question 1 might contain elements of governance, risk, internal control, and will include some aspect of ethics.

One of the features of the Professional level exam papers is the awarding of 'professional marks'. These are marks allocated not for the content of an answer, but for the degree of professionalism with which certain parts of the answer are presented. They will usually be awarded in Section A (the compulsory part of the exam paper) and will total 4 to 6 marks.



It may be, for example, that one requirement asks you to present your answer in the form of, say, a letter, a presentation, a memo, a report, briefing notes, or similar. Some marks may be awarded for the form of the answer in addition to the content of the answer. This might be for the structure, content, style and layout, or the logical flow of arguments in your answer. You should assume that if the question asks for a specific format of answer that some marks may be awarded for an effective presentation of that format.

Section B will contain three questions (Questions 2, 3 and 4) and students will be invited to attempt two from the three questions set. Each question in Section B will, accordingly, be worth a total of 25 marks. In contrast to Question 1, it is likely that the questions in Section B will explore one part of the syllabus in a little more depth. Students should not assume, however, that each question in Section 2 will examine only one part of the syllabus. It is more likely that each will contain an emphasis on one part of the syllabus, while including content from other parts as well. All of the three questions in Section B will be based on a short scenario.

The *Pilot Paper*, which is on the ACCA website, is an illustration of the way the future papers will look and feel. In addition to the *Pilot Paper* - which students will want to study in some depth and eventually attempt - additional pilot questions will also be published.

**David Campbell is examiner for Paper P1**

# AUTHOR'S GUIDANCE

---

1 Preparing for Exams

2 Exam Day Guidance

**Please! Buy Full Version**

# SOLVING SCENARIO BASED QUESTIONS

---

## 1 Overview

### 1.1 Overview of Organization

## 2 Analyzing Requirements

## 3 Reading Scenario

*Exam Support:*

Please! Buy Full Version

# PAST EXAM PAPERS' ANALYSIS

Key Exam Topics	06/12	12/11	06/11	12/10	06/10	12/09	06/09	12/08	06/08	12/07	P/P	P/P sup
	Ethics											
Absolutism Vs. Relativism												
Deontological and teleological ethics												
Kohlberg's cognitive moral development												
Tuckers 5 step model												
AAA model												
Corporate social responsibility												
Social responsibility stances												
Company code of ethics or conduct												
Advantages & disadvantages of codes of ethics												
ACCA code of ethics												
Public interest												
Duty as professional accountant & employee												
Insider dealing												
Independence & threats to independence												
Social & environmental footprint												
Environmental audit												
Sustainability												
Agency theory												
Fiduciary duties												
Agency cost												
AGM vs. EGM												
Remuneration schemes												
Corporate governance benefits												

Key Exam Topics	06/12	12/11	06/11	12/10	06/10	12/09	06/09	12/08	06/08	12/07	P/P	P/P sup
Principles of corporate governance												
Executive & Non-executive directors												
Roles of NEDs												
Adv & dis-adv of NEDs												
Chairman's statement												
Roles of chairman												
Roles of CEO												
Chairman/CEO separation												
Roles of institutional investors												
Roles of trade unions												
Stakeholders identification												
Stock holder vs. stakeholder view												
Instrumental vs. normative view												
Stakeholder management matrix												
Benefits of stakeholders identification												
Considering response to stakeholders												
Nomination committee												
Directors' induction												
Removal of directors												
Problems in directors removal												
Remuneration committee												
Cross directorship corporate governance												
Insider vs. outside systems												

Key Exam Topics	06/12	12/11	06/11	12/10	06/10	12/09	06/09	12/08	06/08	12/07	P/P	P/P sup
Unitary vs. multi-tier board												
International vs. local codes												
Principle vs. rules based approach to C.G & ethics												
Compliance with codes in principle based jurisdictions												
Private vs. public sector												
Principles of good corporate governance												
Risk appetite												
Control environment												
Objectives internal control												
Risk embedding												
Features of IC & RM												
Benefits of internal control												
Identify & define risk												
Risk assessment												
Benefits of risk assessment												
Risk response strategies												
Control activities												
Information & communication												
Inherent limitations of internal controls												
Outsourcing internal controls												
Internal control failures												
Internal control reports												
Audit committee												
Role of internal audit												
Independence of internal audit												

Key Exam Topics	06/12	12/11	06/11	12/10	06/10	12/09	06/09	12/08	06/08	12/07	P/P	P/P sup
Need for internal audit												
Outside vs. in-house appointment of internal auditor												
Role of risk committee												
Benefits of risk committee												
Non-executive risk committee-benefits												
Role of risk manager												
Outsourcing risk management												

Above analysis is given to emphasis the comparative importance of each topic. This analysis can be used as guide for allocating time to topics accordingly.

Do not attempt to guess future question paper from this analysis, as this is historical data and it is not helpful for reading examiners mind at a time of setting exam paper.

Also, see how different exam topics are examined together in single question.

# STUDY PLANNER

## Determine number of days available

### Formula:

$$* \text{Number of days available} = \text{Number of days before exam} - \text{Revision time} - \text{Idle time}$$

Idle time can be incurred due to sickness, computer crash, social events etc. It depends on your daily activities and environment.

I recommend you to make a printed copy to read when computer is not available.

## Allocation of number of days available till exams

### Formula:

$$* \text{Number of days per exam} = * \text{Number of days available} \times \frac{\text{Number of pages}}{\text{Total number of pages}}$$

$$\text{Number of pages per day} = \frac{* \text{Number of pages per exam}}{\text{Number of days allocated}}$$

Number of pages will include allowance for solving past paper questions, student accountant articles etc.

Please note that different syllabus areas will take different amount of time. Calculations will take more time than theoretical areas. Therefore, it will give you only rough idea of your progress.

## Tracking progress

### Formula:

$$\text{Revised no of pages per day} = \frac{\text{Remaining total number of pages}}{\text{Number of days available}}$$

If revised number of page per day is > than originally planned, then you are lagging behind and now you have to do more study per day.

## Troubleshooting

Study at time of day when you are fresh. This will enable you to learn more in available time.



Consider skip reading examples, if you understood theory by reading main text.

Study in the end sub exam topics, which is less likely to be examined in your exam session. You can see past paper analysis given below each sub exam topic.

# ETHICS

Exam Topic 1:

# WAYS TO RESPOND TO ETHICAL DILEMMAS

---

## Sub Exam Topics

S.no	Headings (click the cross-ref below for easy navigation)	Pg.no
1	Ethics	40
2	Absolutism (Cognitivism) Vs. Relativism (Non Cognitivism)	41
3	Deontological Ethics	43
4	Teleological (Consequentialist) Ethics	43
5	Kant's Categorical Imperatives	44
6	Kohlberg's Cognitive Moral Development (KCMD)	45
7	Tuckers 5 Step Model	48
8	American Accounting Association (AAA) Model	50

### *Exam Awareness*

Absolutism / Deontological and Relativism /Teleological ethics is concerned with paths of reaching ethical decision.

Tucker's 5 steps model and AAA model is the framework for deciding ethical course of action. [accasupport.com](http://accasupport.com)

These theories are useful in stakeholder conflict and [internal control](#)<sup>92</sup> failure situation.

See [PAST EXAM PAPERS' ANALYSIS](#) to explore relationships between exam topics. You can use these relationships to gather relevant points across various exam topics that can be used to answer questions.

## 1 Ethics

There are two main approaches to ethics

Ethical decisions remain same in every circumstance.

→ Absolutism (Cognitivism)

→ Deontological Ethics

Ethical decisions depend on situation to situation.

→ Relativism (Non-Cognitivism)

→ Teleological (Consequentialist ethics)

These principles define rationale of individuals behind reaching an ethical decision.

It does not define what the ethical decision should be.

It only defines the path for reaching a decision.

It is possible that followers of two different approaches to ethics reach to same ethical decision.

### *Example:*

*We should speak truth because it is right thing to do (Absolutism & Deontological ethics).*

*If speaking truth leads to right thing then we should speak truth (Relativism & Teleological ethics).*

## 2 Absolutism (Cognitivism) Vs. Relativism (Non Cognitivism)

Exam	Q.no	Requirement	Marks
P/P	Q2:c	Evaluate the proposal from Hanoi House that both Mr Ng and Mr Finn be required to resign from their respective non-executive positions.	5
06/08	Q2:c	Explain how absolutist (dogmatic) and relativist (pragmatic) ethical assumptions would affect the outcome of Anne's decision. <small>accasupport.com</small>	6
12/10	Q1:b	Distinguishing between absolutist and relativist ethics. Evaluating an accountant's view (the accountant who accepted a bonus for her silence) using both of these ethical perspectives.	10

Absolutism	Relativism
One <b>set of universal principles</b> is applicable for ethical decisions in all circumstances and at all times.	Ethical principles <b>changes</b> from situation to situation and time to time. What is ethical will be determined by the situation at that time.
<i>Example:</i> <i>Telling lie is bad habit. It applies either you are telling lie for good or bad cause.</i>	<i>Example:</i> <i>Telling lie is ethical or not will depend on, either you are telling lie for good or bad cause.</i>
<b>Principles</b> will decide ethical decision. However, different principles can be followed by different persons.	<b>Situation and time</b> will decide ethical decision.

Advantages	
No one can make excuse for its unethical behaviour. Therefore, it <b>prevents misuse</b> of power.	It can be applied in situations and times where <b>no principles</b> exist.
It leads to consistency in ethical decision. This increases <b>public confidence</b> on decision taken.	It can be useful in <b>conflict resolution</b> between employees and different departments of the organization.
Decisions can be reached <b>quickly</b> (timely) and so <b>cost effectively</b> (economically). <small>accasupport.com</small>	It takes account of <b>changing</b> circumstances. <i>Example:</i> <i>Slavery is deemed as ethical in past. However, it is considered unethical today.</i>
	Understanding and interpretation of ethical <b>principles is not required.</b> <i>Example:</i> <i>People should be treated fairly. However, what is fair treatment?</i>
Disadvantages	

<b>Advantages</b>	
<p>Problems arises when <b>two absolutist</b> following different principles.</p> <p><i>Example:</i> <i>In some religions, animal products are prohibited, while not in other religions.</i></p>	<p>It will be <b>time consuming and costly</b> to reach an ethical decision in this way.</p>
<p>In complex environment; where circumstances (situation) <b>changes rapidly</b>. It would be difficult to apply same decision in every ethical dilemma.</p> <p><i>Example:</i> <i>Reporting on non-compliance with health and safety regulation may be ethical. However, it may reduce market share price (shareholder wealth). In addition, if company goes into compulsory winding up, then employees will lose their jobs.</i></p>	<p>Unethical decision can be <b>justified</b> (every decision is ethical) on the grounds of relativism, regardless of minority suffers as a result.</p> <p style="text-align: center;"><small>accasupport.com</small></p> <p><i>Example:</i> <i>Undertaking a risky project can be justified as ethical because, it will increase shareholders wealth. However, it is unethical to risk debt holders' money, as they will not get an additional benefit (from the risky project) above interest payments.</i></p>

### 3 Deontological Ethics

Exam	Q.no	Requirement	Marks
P/P	Q3:c	Explain and contrast a deontological with a consequentialist-based approach to business ethics.	6
12/08	Q4:c	Assess Mr Hogg's belief that employing child labour is 'always ethically wrong' from deontological and teleological (consequentialist) ethical perspectives.	9

Deontological ethics assumes that only one **universal set of principles** exists on which ethical decisions should be based.

It is similar in logic to absolutism approach to ethics.

### 4 Teleological (Consequentialist) Ethics

#### 1) Utilitarianism

It means greatest **happiness for greatest** number of people.

Decision is ethical if it benefits majority of people, no matter if **minority suffers** as a result.

*Example:*

*Politicians are elected based on majority votes (happiness) by majority voters (people). It does not consider how minority voters will be affected by the policies of politicians.*

## 2) Egoism

It means what is best for **me**?

Decision is ethical if it benefits decision maker, no matter how it affects others.

*Example:*

*It is worth taking risk (investment) if it will earn me additional reward such as bonus, regardless of its **impact** on organizational stability.*

## 5 Kant's Categorical Imperatives

Categorical imperatives (Reasons behind decision) are consistent with the deontological ethics. Ethical principles should be based on **moral duties** without considering outcome of decision.

Kant believed that decision is ethical, if following three imperatives are met.

1) Treat others, as you would like to be treated by others.

*Example:*

*Do not laugh at others if you do not like that others laugh at you.*

2) Treat people as an end rather than as a means to an end.

It means do not use human beings as a tool to achieve your goal instead respect rights of other human beings in first place.

*Example:*

*Do not use child labour as cheap source of human resource.*



- 3) Act in accordance with universal principles of ethics such as integrity and fairness.

*Example:*

*Always speak the truth regardless of reward such as bribe offered to tell a lie.*

## 6 Kohlberg's Cognitive Moral Development (KCMD)

Exam	Q.no	Requirement	Marks
P/P sup	Q1:b	Assess Jenny's decision on the possible apology for the 'offending' image from conventional and pre-conventional moral development perspectives.	4
12/07	Q1:b	Explain Kohlberg's three levels of moral development and identify the levels of moral development demonstrated by the contributions of Gary Howells, Vanda Monroe and Martin Chan.	12
06/09	Q1:a(i)	Explain the three levels of Kohlberg's theory.	6
06/09	Q1:a(ii)	Identify the level that Mr Mineta operated at and justify your choice using evidence from the case.	4
06/09	Q1;a(iii)	Identify, with reasons, the stage (or 'plane') of Kohlberg's moral development most appropriate for a professional bank employee such as Mr Mineta as he undertakes his trading duties.	2
06/11	Q1:b	Explain Kohlberg's three levels of moral development and identify, with reasons, the levels of development exhibited by James Tsakos, Kathy Yao and Vernon Vim.	12

Kohlberg's CMD is concerned with reasons for taking particular decision. It does not explain, how to take ethical decisions rather it explains, why individuals behave in particular way.

## 1) Level1: Pre-Conventional Moral Development

### Exam Support

*If marks allocated do not justify break down of levels into stages then skip the stages and just explain it into 3 levels.*

### Stage1

Individual takes decisions based on **rewards and punishment**.

### Example:

*Taking excessive risk is justified if it earns me more reward, regardless of how it affects others.*

*To avoid being penalised, tax return should be submitted within due date.*

### Stage2

Individual decisions are based on **give and take basis**. It means i will do a favour for you, if in turn you will do the same for me in future.

accasupport.com

### Example:

*If you will be unable to come tomorrow at workplace, then i will do your part of work, if you are willing to do the same for me in future.*

accasupport.com

## 2) Level 2: Conventional Moral Development

### Stage1

Individual decisions are based on the **expectations** of the immediate environment (surrounding), friends and co-workers.

### Example:

*If everyone in a family is going to picnic, then i should go too, probably not to upset them.*

*Internal controls<sup>92</sup> should be followed because co-workers are following them.*

## Stage2

Individual takes decision based on **social norms and legal rules**.

### *Example:*

*Comply with company law because letter of law should be obeyed.*

*Compliance with corporate governance<sup>72</sup> codes as it is good practice and expected by stakeholders<sup>79</sup> such as society.*

## 3) Level 3: Post Conventional Moral Development

### Stage1

Individual decisions are **Independent<sup>72</sup>** of social and legal norms. If individual thinks that certain behaviour is unethical, he/she will not follow it whatever the law and social norms suggests.

### *Example:*

*Drinking alcohol is legal in some societies. However, if individual believes that drinking alcohol is bad habit, he/she will not drink alcohol whether others are drinking or not.*

accasupport.com

### Stage2

Individual decisions are based on **universal ethical principles**.

### *Example:*

accasupport.com

*Professional accountant maintaining integrity at all times without considering an outcome of his/her decision on his career.*

## 7 Tuckers 5 Step Model

Exam	Q.no	Requirement	Marks
12/08	Q1:a	Assess the secrecy option using Tucker's model for decision-making.	10
06/10	Q2:c	Construct an ethical case for Mr Woof to voluntarily accept a reduction in his pension value in recognition of his failure as chief executive of Tomato Bank.	5

According to Tucker, ethical decisions can be reached by answering the following 5 questions.

According to Tucker, if answer is yes then individual should proceed to the next question. However, in exams you should always discuss all the 5 questions.

### *Exam Support:*

*Use this model for profit making organization or in situation where financial issue is involved. Its step 1 (is it profitable?) makes it more useful in context of profit making organization rather than not for profit organization.*

accasupport.com

### 1) Is It Profitable?

Profitable to whom and how much is a matter of judgement.

accasupport.com

### *Exam Support:*

*Look for stakeholders<sup>79</sup> mentioned in the scenario.*

### 2) Is It Legal?

Legality of decision depends on **jurisdiction**, which is applicable to the organization.

### *Exam Support:*

*Look for information given about legislations applicable to the ethical problem.*

### 3) Is It Fair?

Fair means Objective, balanced, equal treatment, avoiding bias, prejudice, discrimination etc.

Fair to whom is a matter of **judgement**.

*Exam Support:*

Look for *stakeholders*<sup>79</sup> which organization recognizes while making decisions.

4) Is It Right?

Answer to this question depends on the **ethical perspective** (absolutism or relativism) of the individual.

*Exam Support:*

Look for *ethical perspective of manager or employee in ethical problem.*

5) Is It Sustainable?

accasupport.com

**Sustainability** means ability to continue particular activity till foreseeable future.

*Example:*

*Using fossil fuel as a source of energy will deprive reserves for future generations. However, it can be sustainable if we can replace fossil fuel with some other source of energy such as solar energy for the use of future generations.*

accasupport.com

Sustainable to whom and how long is matter of **judgement**.

*Exam Support:*

*Look for information on organizational background and policies.*

According to Tucker, if all the answers to above questions are yes, then decision is ethical.

8 American Accounting Association (AAA) Model

Exam	Q.no	Requirement	Marks
12/09	Q1:a	<i>The independent consultant's advice was that the Mary Jane should have received structural work to make her safe for operating in the rougher seas of the Northport route. Sea Ships Company did not act on the advice.</i> Using the seven-step American Accounting Association (AAA) model for ethical decision-making, examine the company's dilemma on whether or not to disclose this information publicly. <small>accasupport.com</small>	14
12/09	Q3:c	Critically evaluate the alternatives that John Wang has in his ethical dilemma.	10
06/10	Q4:c	Discuss the professional and ethical dilemma facing Mr Shreeves in deciding whether or not to tell Ken and Steffi about Ivan's activity. Advise Mr Shreeves of the most appropriate course of action.	8
06/12	Q1:b	Use the AAA (American Accounting Association) seven-step model to examine the ethical decision whether to select the Jayland option or the Pealand option.	14

AAA model asks 7 questions to reach an ethical decision.

*Exam Support:*

*AAA model is lengthy than tuckers 5 step model. However, it can be used in case of profit as well as not for profit organization.*  
accasupport.com

*Always use the model recommended by the examiner. You should aware of abbreviations (AAA, KCMD etc) to identify the recommended model.*

1) What Are The Facts Of The Case?

You can present a **summary** of present situation taken from a scenario.

*Exam Support:*

*Do not copy/past text from scenario.*

*Example:*

*A labour son is seriously ill and needs urgent treatment if he has to survive. However, the labour has not enough money for his treatment.*

## 2) What Are The Ethical Issues In The Case?

Ethics issues are the ethical **principles** are at risk.

*Example:*

*Is it **fair** to steal goods from the factory and sell them in the market for money, so that his son can be saved?*

## 3) What Are Norms, Principles & Values Related To The Case?

These can be policies, past practices of the organization and **comments** made by individual managers or employees.

*Example:*

*Stealing goods from the factory is considered unethical. In addition, the labour **told his son** not to steal others objects.*

## 4) What Are The Alternative Courses Of Action?

These are different **options available** to solve ethical dilemma in given situation.

accasupport.com

*Example:*

***Alternative 1:** Labour can take his son to the charitable hospital. However, he is concern about quality of treatment.*

***Alternative 2:** He can borrow money from the factory and repay it from the next month's salary.*

***Alternative 3:** Labour can steal goods from the factory and sell it for money in the market.*

accasupport.com

### 5) What Is The Best Course Of Action?

**Best course of action** should be decided in **comparison** with norms, principles and values identified in step 3 and alternative courses of action in step 4.

*Example:*

*In this case, taking his son to the **charitable hospital** is best course of action taking account of urgency of treatment needed.*

### 6) What Are The Consequences Of Each Alternative Course Of Action?

These are the possible **impact** of each alternative course of action on the position of personnel or organization involved in ethical dilemma.

*Example:*

*Alternative 1 will enable the labour to provide his son an **urgent treatment** at little or no fee at all.*

*Alternative 2 will enable him giving **treatment** at a place he wishes. However, it will increase **debt burden**, which he cannot bear.*

*Alternative 3 will enable him to **save his son**, but if was caught, he can face **imprisonment or fine**. In addition, he will set a wrong example for his son, which will be opposite to what he has told his son not to steal others objects.*

### 7) What Is The Decision?

Final decision after considering above information will **depend on individual**.

You should always **recommend** a decision giving **justification** for your decision.

*Example:*

*It depends on labour what he considers worthwhile course of action. However, labour should that his son to **charitable hospital** as this provide urgent treatment and will save him from committing **legal offence** and **setting wrong example** for his son.*



*Exam Support:*

*Whatever course of action you recommend, you have to give reasons to justify your comments.*

*There can be more than one solution to ethical problem question. Therefore, you will only get marks if you have given reasons behind your recommendations.* [accasupport.com](http://accasupport.com)

*Recommendations are usually required where (evaluate, advice, recommend, speech etc) verbs are used in the question.*

Exam Topic 2:

# CORPORATE SOCIAL RESPONSIBILITY & ETHICAL STANCES

---

Sub Exam Topics

S.no	Headings (click the cross-ref below for easy navigation)	Pg.no
1	<a href="#">Corporate Social Responsibility</a>	55
2	<a href="#">Corporate Citizenship</a>	55
3	<a href="#">Perspectives of Corporate Citizenship</a>	56
4	<a href="#">Social Responsibility Stances (Positions)</a>	57

## *Exam Awareness*

Corporate social responsibility and citizenship are very frequently debated topics of [corporate governance](#)<sup>72</sup>.

You can expect above sub exam topics in combination with identification of [stakeholders](#)<sup>79</sup> and management. [accasupport.com](http://accasupport.com)

See [PAST EXAM PAPERS' ANALYSIS](#) to explore relationships between exam topics. You can use these relationships to gather relevant points across various exam topics that can be used to answer questions.

## 1 Corporate Social Responsibility

Exam	Q.no	Requirement	Marks
12/10	Q4:d	Criticise the voluntary supplier payment policy as a means of demonstrating UU's social responsibility.	5
12/11	Q4:c	Define 'social responsibility' as used by Albert Doo. Contrast how short and long-term shareholder interest perspectives may affect Biggo's attitude to the requested contribution for the children's play area.	9

Carol has identified four stances (positions) of ethical responsibility.

### 1) Economic Responsibility

Economic responsibility focuses on **shareholders wealth maximization**. Treatment to other [stakeholders](#)<sup>79</sup> depends on effect on shareholders wealth.

### 2) Legal Responsibility

Legal responsibility focuses on **compliance** with laws and regulations. Compliance with [corporate governance](#)<sup>72</sup> codes such as Sarbanes Oxley act in US is subject to legal responsibility in rule-based jurisdictions.

### 3) Ethical Responsibility

Ethical responsibility focuses on **commitment** with ethical and voluntary codes. It involves fulfilment of social expectations which not covered by law.

Ethics is the behaviour required by the society.

### 5) Philanthropic Responsibility

Philanthropic responsibility focuses on **commitment** beyond social expectations. It involves commitment with those aspects of ethics, which laws and voluntary codes failed to address.

## 2 Corporate Citizenship

Boson centre for corporate citizenship defines:

”Corporate citizenship is the business strategy that shapes the values underpinning a company’s mission and the choices made each day by its executives, managers and employees as they engage with society. Three core principles define the essence of corporate citizenship, and every company should apply them in a manner appropriate to its distinct needs: minimizing benefit and being accountable and responsive to [stakeholders](#)”.

## 2.1 Explanation

Corporate citizenship is concept is based on idea that company as being **separate legal entity** should behave in socially acceptable manner, just like humans as being living entity is expected to behave in socially acceptable manner.

[accasupport.com](http://accasupport.com)

In addition, shareholders get benefit from **limited liability protection** by having an investment in a company. Therefore, it is justifiable to expect companies to spend its resources to benefit the society and minimize its negative impact upon the society, other than maximizing shareholders wealth.

## 2.2 Objectives

Objectives of corporate citizenship are:

- Minimizing harm to society.
- Maximizing benefits to society.
- Accountability to [stakeholders](#).

## 3 Perspectives of Corporate Citizenship

Matten et al writer on corporate citizenship suggests three perspectives.

### 1) Limited View

Limited view considers **economic development** as only responsibility under corporate citizenship. Corporate citizenship under this view focuses on limited number of [stakeholders](#) that can affect economic performance of the organization.

[accasupport.com](http://accasupport.com)

### 2) Equivalent View

Equivalent view considers **compliance** with law and ethical codes as responsibility under corporate citizenship. Corporate citizenship under this view focuses on society and economic development is not the only motivation.

### 3) Extended View

Extended view also considers **commitment** with ethical aspects, which society, law and ethical codes fail to address. It attempts to use corporate power to protect political, social, human rights etc of individuals in the society.

Note corporate social responsibility and citizenship is limited to society, it does not recognize environment as stakeholder to company.

## 4 Social Responsibility Stances (Positions)

Exam	Q.no	Requirement	Marks
12/07	Q4:b	Compare and contrast Gray, Owen and Adams's 'pristine capitalist' position with the 'social contractarian' position. Explain how these positions would affect responses to stakeholder concerns in the new stadium project.	8
06/09	Q2:c	Assess Ivor Nahum's remarks about the accounting profession in the light of Gray, Owen & Adams' deep green (or deep ecologist) position on social responsibility.	7
06/11	Q1:d(ii)	A defence of the company's decisions on the Bobo Foo from a 'pristine capitalist' ethical perspective (using Gray, Owen & Adams's framework).	6
12/11	Q4:a	Explain the meaning of 'rights' and 'responsibilities' in the context of Biggo and describe how these terms are interpreted at the two ends of the Gray, Owen & Adams 'continuum'.	10
12/11	Q4:b	Justify, using evidence from the case, which of Gray, Owen & Adams's positions are best described by the comments made by Robert Tens and also Margaret Heggs.	6

Gray, Owen and Adams have prescribed seven ethical positions of individuals and companies. These positions move from focus on financial benefit to focus on environmental and society along a continuum.

accasupport.com

### *Exam Support:*

*Most common form of organization presented in scenario-based questions is company. Their investors are shareholders and management are board of directors.*

#### 1) Pristine Capitalist

It argues that primary purpose of the profit making organizations is to **maximize the wealth of its investors**. Usage of investor's money for purpose other than maximize of wealth is effectively theft.

This stance is similar to **Stock Holder vs. Stakeholder View of corporate governance**<sup>72</sup>.

accasupport.com

Followers of this stance will disregard the concerns of other **stakeholders**<sup>79</sup> in favour shareholders.

#### 2) Expedients

It argues that organization should behave in **socially responsible manners** if it leads to increase in maximization of shareholders (investors) wealth.

This stance is similar to **Instrumental vs. Normative View of stakeholders**<sup>79</sup> management.

accasupport.com

Followers of this stance will consider **stakeholders**<sup>79</sup> if this benefits shareholders in return.

#### 3) Social Contract

It argues that organization takes **input from society** to survive and grow. Actions of the organization against the social and cultural norms will upset the society. Thus, organization will no longer survive without the input from the society.

accasupport.com

### *Example:*

*Supplier will refuse supplying goods, if retailer is selling their products through email spamming.*

*Customers will boycott the organizational products, if products quality is below acceptable level.* accasupport.com

Followers of this stance will consider **stakeholders**<sup>79</sup> to comply with social expectations to avoid any action against the organization.

#### 4) Social Ecologist

Organizations operating in the environment leave its impact (**footprint**) on the environment and society. Organizations therefore assume responsibility to reduce and **eliminate the impact** of their actions.

#### *Example:*

*Usage of fossil fuel, reducing the oxygen in the environment should be balanced by taking measures such as planting new trees or consider using green source of energy such as solar system.* accasupport.com

Followers of this stance will consider concerns of **stakeholders**<sup>79</sup> to the extent of environmental and society footprint created by the organization.

### 5) Socialists

Socialists argue that traditional organizations focus on the interest of its investors. This will lead to concentration of wealth in few hands in the society and create imbalance of power, which can be used against poor people.

They argued that all **stakeholders**<sup>79</sup> should be **treated equally** and this should be reflected in organization policies and code of good governance.

Followers of this stance will provide equal treatment to all **stakeholders**<sup>79</sup> and shareholders regardless of how the shareholders will be affected.

### 6) Radical Feminists

They argued that existing business culture is associated with **masculine values** such as competition, and rigid timings. Business should be performed with **feminine value** such as team working and flexible timings. To do this fundamental redesign of existing processes and policies are needed.

Followers of this stance will give primary importance to **stakeholders**<sup>79</sup>. Wealth will only be maximized after satisfying all other stakeholders.

### 7) Deep Ecologists

They argued that human beings have **no special rights** over other **species and environment**. Current system cannot be repaired to reflect this idea. Entirely new system needs to be implemented from zero.

Followers to this stance will give no special rights to human beings and will not pursue economic development, if it does harm to the environment, society, wildlife and undiscovered species.



Exam Topic 3:

# PROFESSIONAL'S PRACTICE & CODES OF ETHICS

---

Sub Exam Topics

S.no	Headings (click the cross-ref below for easy navigation)	Pg.no
1	<a href="#">Purpose of Company Codes of Ethics or Conduct</a>	62
2	<a href="#">Contents of Codes of Ethics or Conduct</a>	62
3	<a href="#">Roles of Codes of Ethics in Strategic Positioning</a>	62
4	<a href="#">Advantages &amp; Disadvantages of Codes of Ethics</a>	62
5	<a href="#">ACCA Code of Ethics &amp; Conduct</a>	62
6	<a href="#">Accountant as a Professional</a>	62
7	<a href="#">Duty as Professional Accountant &amp; an Employee</a>	62
8	<a href="#">Duty as Professional Accountant &amp; an Employee</a>	62

*Exam Awareness*

- 1 Purpose of Company Codes of Ethics or Conduct
- 2 Contents of Codes of Ethics or Conduct
- 3 Roles of Codes of Ethics in Strategic Positioning
- 4 Advantages & Disadvantages of Codes of Ethics
  - 4.1 Advantages of Ethical Codes
  - 4.2 Disadvantages of Ethical Codes
- 5 ACCA Code of Ethics & Conduct
  - 1) Objectivity
  - 2) Integrity
  - 3) Professional Competence
  - 4) Confidentiality
  - 5) Professional Behaviour

Professional behaviour should be considered from the eyes of public.
- 6 Public Interest
- 7 Accountant as a Professional
- 8 Duty as Professional Accountant & an Employee

Exam Topic 4:

# THREATS TO ETHICS & SAFEGUARDS

---

## Sub Exam Topics

S.no	Headings (click the cross-ref below for easy navigation)	Pg.no
1	<a href="#">Insider Dealing</a>	64
2	<a href="#">Independence of Auditors</a>	64
3	<a href="#">Threats to Independence of Auditors</a>	64

## *Exam Awareness*

- 1 Insider Dealing
  
- 2 Independence of Auditors
  
- 3 Threats to Independence of Auditors
  - 1) Self Interest Threat
  - 2) Familiarity Threat
  - 3) Self-Review Threat
  - 4) Advocacy Threat

Exam Topic 5:

# SOCIAL & ENVIRONMENTAL ISSUES

---

## Sub Exam Topics

S.no	Headings (click the cross-ref below for easy navigation)	Pg.no
1	Social & Environmental Footprint	66
2	Importance of Environmental Reporting	66
3	Externalities	66
4	Environmental Auditing	66
5	Sustainability	66
6	Strong vs. Weak Sustainability	66

## *Exam Awareness*

- 1 Social & Environmental Footprint
  - 1) Positive Footprint
  - 2) Negative Footprint
- 2 Importance of Environmental Reporting
- 3 Externalities
- 4 Environmental Auditing
  - 1) First Stage
  - 2) Second Stage
  - 3) Third Stage
- 5 Sustainability
- 6 Strong vs. Weak Sustainability

# GOVERNANCE

Exam Topic 6:

# NEED FOR CORPORATE GOVERNANCE

---

## Sub Exam Topics

S.no	Headings (click the cross-ref below for easy navigation)	Pg.no
1	<a href="#">Agency Theory</a>	69
2	<a href="#">Transaction Cost Theory</a>	69
3	<a href="#">Fiduciary Duties</a>	69
4	<a href="#">Agency Problem</a>	69
5	<a href="#">Agency Cost</a>	69
6	<a href="#">Illustration of Agency Relationship</a>	69
7	<a href="#">Annual General Meeting (AGM) Vs. Extra Ordinary General Meeting (EGM)</a>	69
8	<a href="#">Remuneration Schemes to Address Agency Problem</a>	69
9	<a href="#">Good Remuneration Package</a>	70

## *Exam Awareness*



- 1 Agency Theory
- 2 Transaction Cost Theory
- 3 Fiduciary Duties
  - 3.1 Fiduciary Duties & Board of Directors
  - 3.2 Fiduciary Duties
    - 1) Duty Of Responsibility For Power
    - 2) Duty To Avoid Conflict Of Interest
    - 3) Duty Of Obedience
    - 4) Duty Of Reimbursement
    - 5) Duty Of Confidentiality
    - 6) Duty Of Skill & Performance
    - 7) Duty Of Provide Personal Services
- 4 Agency Problem
- 5 Agency Cost
  - 5.1 Attempts to Reduce Agency Problem
- 6 Illustration of Agency Relationship
- 7 Annual General Meeting (AGM) Vs. Extra Ordinary General Meeting (EGM)
- 8 Remuneration Schemes to Address Agency Problem
  - 1) Basic Pay
  - 2) Bonus

3) Share Based Payment

4) Pension

5) Benefits

8.1 Performance Related Reward Schemes

1) Profit Related Pay

2) Share Options

9 Good Remuneration Package

Exam Topic 7:

# BASICS OF CORPORATE GOVERNANCE

---

## Sub Exam Topics

S.no	Headings (click the cross-ref below for easy navigation)	Pg.no
1	Corporate Governance Definition	72
2	Benefits of Corporate Governance	72
3	Basic Principles of Corporate Governance	72
4	Illustration of Basic Principles Relationship	72

## *Exam Awareness*

- 1 Corporate Governance Definition
- 2 Benefits of Corporate Governance
- 3 Basic Principles of Corporate Governance
  - 1) Fairness
  - 2) Honesty/Probity
  - 3) Openness/Transparency
    - 3.1 Role of Transparency in Relevance & Reliability of Information
    - 3.2 Conflict with Duty of Confidentiality
  - 4) Responsibility
  - 5) Accountability
  - 6) Independence
  - 7) Judgement
  - 8) Integrity
  - 9) Reputation
- 4 Illustration of Basic Principles Relationship

Exam Topic 8:

# ROLES OF CEO, CHAIRMAN, & NEDs

---

## Sub Exam Topics

S.no	Headings (click the cross-ref below for easy navigation)	Pg.no
1	Executive & Non-Executive Directors	74
2	Roles of NEDs (Non-Executive Directors)	74
3	Advantages & Disadvantages of NEDs	74
4	Importance of Chairman's Statement	74
5	Roles of Chairman	74
6	Roles of CEO	74
7	Chairman & CEO Separation	75
8	Benefit & Limitations of Chairman/CEO Separation	75

## *Exam Awareness*

- 1 Executive & Non-Executive Directors
- 2 Roles of NEDs (Non-Executive Directors)
  - 1) Scrutiny
  - 2) People
  - 3) Risk Management
  - 4) Strategy
- 3 Advantages & Disadvantages of NEDs
  - 3.1 Advantages
  - 3.2 Disadvantages
- 4 Importance of Chairman's Statement
- 5 Roles of Chairman
  - 1) Board Leadership
  - 2) Quality Of Information
  - 3) Ensuring Adequate Time
  - 4) Facilitating NEDs
  - 5) Board Development
  - 6) Performance Evaluation
  - 7) Financial Statements
  - 8) Dealing With Shareholders
- 6 Roles of CEO
  - 1) Strategic Decisions
  - 2) Internal Control & Risk Management

- 3) Recommending To Board Committees
- 4) Investment & Financing
  
- 7 Chairman & CEO Separation
  
- 8 Benefit & Limitations of Chairman/CEO Separation

Exam Topic 9:

# OTHER IMPORTANT STAKEHOLDERS

---

## Sub Exam Topics

S.no	Headings (click the cross-ref below for easy navigation)	Pg.no
1	Roles of Institutional Investors	77
2	Roles of Trade Unions	77
3	Sub Management & Employees	77
4	Suppliers & Customers	77
5	External Auditors	77
6	Stock Exchange	77
7	Company Secretary	77

## *Exam Awareness*



- 1 Roles of Institutional Investors
- 2 Roles of Trade Unions
- 3 Sub Management & Employees
- 4 Suppliers & Customers
- 5 External Auditors
- 6 Stock Exchange
- 7 Company Secretary

Exam Topic 10:  
**STAKEHOLDERS IDENTIFICATION &  
MANAGEMENT**

---

Sub Exam Topics

S.no	Headings (click the cross-ref below for easy navigation)	Pg.no
1	Stakeholders Definition	79
2	Classification & Identification of Stakeholders	79
3	Stock Holder vs. Stakeholder View	79
4	Instrumental vs. Normative View	79
5	Stakeholder Management Matrix	79
6	Considering Response to Stakeholders	80
7	Benefits & Limitations of Mendelow Matrix	80

*Exam Awareness*

- 1 Stakeholders Definition
- 2 Classification & Identification of Stakeholders
  - 1) Internal Vs. Connected Vs. External
  - 2) Direct Vs. Indirect
  - 3) Primary Vs. Secondary
  - 4) Narrow Vs. Wide
  - 5) Voluntary Vs. Involuntary
  - 6) Known Vs. Unknown
  - 7) Recognized Vs. Unrecognized
  - 8) Legitimate Vs. Illegitimate
- 3 Stock Holder vs. Stakeholder View
- 4 Instrumental vs. Normative View
- 5 Stakeholder Management Matrix
  - 1) High Power/ High Interest
  - 2) High Power/Low Interest
  - 3) Low Power/High Interest
  - 4) Low Power/Low Interest

## 6 Considering Response to Stakeholders

Legitimacy of stakeholders asserting claims on the organization should be considered.

Urgency of stakeholders should be considered also. If stakeholders require immediate action, then they are considered more powerful. Urgency coupled with legitimacy provides sufficient power to the stakeholders.

Level of interest should be considered. If stakeholders are highly affected or can highly affect, then they need thorough response.

Organization values, norms and company code of ethics and conduct should be considered when deciding response to stakeholders.

## 7 Benefits & Limitations of Mendelow Matrix

Exam Topic 11:

# NOMINATION & REMUNERATION COMMITTEES

---

Sub Exam Topics

S.no	Headings (click the cross-ref below for easy navigation)	Pg.no
1	Roles of Nomination Committee	82
2	Composition of Nomination Committee	82
3	Contents of Director's Induction Programme	82
4	Advantages of Induction Programme for Directors	82
5	Advantages Induction Programme For Organization	82
6	Disadvantages of Induction Programme	82
7	Appointment of Directors	82
8	Removal of Directors	82
9	Length of Service & Problems in Director's Removal	82
10	Role of Remuneration Committee	83
11	Composition of Remuneration Committee	83
12	Cross Directorship & Corporate Governance	83

*Exam Awareness*

- 1 Roles of Nomination Committee
- 2 Composition of Nomination Committee
- 3 Contents of Director's Induction Programme
- 4 Advantages of Induction Programme for Directors
- 5 Advantages Induction Programme For Organization
- 6 Disadvantages of Induction Programme
- 7 Appointment of Directors
- 8 Removal of Directors
  - 1) Dissolution Of A Company
  - 2) Removal By Resolution
  - 3) Removal on Expiry of Service Contract
  - 4) Removal By Not Submitting For Re-Election
  - 5) Removal by Disqualification
  - 6) Death Of Director Or Loss Of Mental Balance
  - 7) Removal By Absence
  - 8) Voluntary Redundancy
  - 9) Compulsory Redundancy
  - 10) Retirement By Rotation
    - 10.1) Benefits Of Retirement By Rotation
- 9 Length of Service & Problems in Director's Removal

10 Role of Remuneration Committee

11 Composition of Remuneration Committee

12 Cross Directorship & Corporate Governance

Exam Topic 13:

# GOVERNANCE SYSTEM & STRUCTURES

---

Sub Exam Topics

S.no	Headings (click the cross-ref below for easy navigation)	Pg.no
1	Insider vs. Outsider Systems	85
2	Unitary Vs. Multi-Tier Board	85

*Exam Awareness*



## 1 Insider vs. Outsider Systems

## 2 Unitary Vs. Multi-Tier Board

### 2.1 Illustration for Unitary & Multi-Tier Board

Exam Topic 14:

# RULES & PRINCIPLES OF GOVERNANCE

---

Sub Exam Topics

S.no	Headings (click the cross-ref below for easy navigation)	Pg.no
1	<a href="#">International vs. Local Codes of Corporate Governance</a>	87
2	<a href="#">Principle Based Vs. Rules Based Approach to Corporate Governance &amp; Ethics</a>	87
3	<a href="#">Compliance with Codes in Principle Based Jurisdictions</a>	87
4	<a href="#">Private vs. Public Sector Governance</a>	87
5	<a href="#">Principles of Good Corporate Governance</a>	87

*Exam Awareness*

- 1 International vs. Local Codes of Corporate Governance
- 2 Principle Based Vs. Rules Based Approach to Corporate Governance & Ethics
- 3 Compliance with Codes in Principle Based Jurisdictions
- 4 Private vs. Public Sector Governance
- 5 Principles of Good Corporate Governance
  - 5.1 Board
  - 5.2 Auditors
  - 5.3 Internal Control
  - 5.4 Committees
  - 5.5 Communication & Reporting
  - 5.6 Shareholders
  - 5.7 Other Stakeholders

# RISK

Exam Topic 15:

# INTERNAL CONTROL & RISK MANAGEMENT FRAMEWORK

---

Sub Exam Topics

S.no	Headings (click the cross-ref below for easy navigation)	Pg.no
1	<a href="#">Risk Management System (COSO Framework)</a>	90

## *Exam Awareness*

It forms the base of [internal control](#)<sup>92</sup> and risk management. All other exam topics are based on this exam topic.

See [PAST EXAM PAPERS' ANALYSIS](#) to explore relationships between exam topics. You can use these relationships to gather relevant points across various exam topics that can be used to answer questions.

- 1 Risk Management System (COSO Framework)
  - 1) Control Environment
  - 2) Event Identification
  - 3) Objective Setting
  - 4) Risk Assessment
  - 5) Risk Response
  - 6) Control activities or procedures
  - 7) Information & Communication
  - 8) Monitoring

Exam Topic 16:

# BEST PRACTICE FOR INTERNAL CONTROL & RISK MANAGEMENT

---

Sub Exam Topics

S.no	Headings (click the cross-ref below for easy navigation)	Pg.no
1	<a href="#">Objectives of Internal Control System</a>	92
2	<a href="#">Risk Embedding</a>	92
3	<a href="#">Features of Sound System of Internal Control &amp; Risk Management</a>	92
4	<a href="#">Benefit of Sound System of Internal Control</a>	92
5	<a href="#">Elements of Strong Internal Control Environment</a>	92

*Exam Awareness*

- 1 Objectives of Internal Control System
- 2 Risk Embedding
- 3 Features of Sound System of Internal Control & Risk Management
- 4 Benefit of Sound System of Internal Control
- 5 Elements of Strong Internal Control Environment



Exam Topic 17:

# RISK IDENTIFICATION

---

## Sub Exam Topics

S.no	Headings (click the cross-ref below for easy navigation)	Pg.no
1	Definition of Risk & Uncertainty	94
2	Risk Appetite	94
3	Categories of Risk	94
4	Risks at Different Areas in Organization	94
5	Risk Identification	94
6	Environmental Risk	95
7	Reputation Risk	95
8	Illustration of Risk Relationships	95

## *Exam Awareness*

- 1 Definition of Risk & Uncertainty
  - 1.1 Risk
    - 1) Impact (Hazard)
    - 2) Probability
  - 1.2 Uncertainty
- 2 Risk Appetite
  - 1) Risk Attitude
  - 2) Risk Capacity
- 3 Categories of Risk
  - 3.1 Fundamental Risk
  - 3.2 Particular Risk
  - 3.3 Speculative Risk
  - 3.4 Pure Risk
  - 3.5 Entrepreneurial Risk
- 4 Risks at Different Areas in Organization
  - 4.1 Strategic Risk
  - 4.2 Operational Risk
  - 4.3 Business Risk
  - 4.4 Non Business Risk
- 5 Risk Identification
  - 5.1 Market Risk
    - 5.1.1 Interest Rate Risk

## 5.1.2 Foreign Exchange Risk

### 5.1.2.1 Translation Risk

### 5.1.2.2 Transaction Risk

### 5.1.2.3 Economic Exposure Risk

## 5.2 Technological Risk

## 5.3 Information Technology Risk

### 5.3.1 Hacker Risk

### 5.3.2 Data Protection Risk

### 5.3.3 Intellectual Property Risk

## 5.4 Political Risk

## 5.5 Catastrophe Risk

## 5.6 Liquidity Risk

## 5.7 Credit Risk

## 5.8 Financial Reporting Risk

## 5.9 Legal Risk

## 5.10 Fraud Risk

## 5.11 Human Resource Risk

## 5.12 Customer Risk

## 5.13 Environmental Risk

## 5.14 Social & Cultural Risk

## 5.15 Reputation Risk

## 6 Illustration of Risk Relationships

Exam Topic 18:

# RISK ASSESSMENT, RESPONSE & CONTROL ACTIVITY

---

Sub Exam Topics

S.no	Headings (click the cross-ref below for easy navigation)	Pg.no
1	<a href="#">Risk Assessment Framework</a>	97
2	<a href="#">Benefits of Risk Assessment</a>	97
3	<a href="#">Risk Response Strategies (TARA Framework)</a>	97
4	<a href="#">Control Activities or Procedures</a>	97

*Exam Awareness*

- 1 Risk Assessment Framework
  - 1) High Impact/ High Probability
  - 2) High Impact/ Low Probability
  - 3) Low Impact/ High Probability
  - 4) Low Impact/ Low Probability
  
- 2 Benefits of Risk Assessment
  
- 3 Risk Response Strategies (TARA Framework)
  - 1) Transfer
  - 2) Accept
  - 3) Reduce
  - 4) Avoid
  
- 4 Control Activities or Procedures
  - 1) Supervision
  - 2) Organization
  - 3) Authorization And Approval
  - 4) Personnel
  - 5) Segregation Of Duties
  - 6) Physical Control
  - 7) Arithmetical & Accounting
  - 8) Management

Exam Topic 19:

# INFORMATION & COMMUNICATION & MONITORING

---

## Sub Exam Topics

S.no	Headings (click the cross-ref below for easy navigation)	Pg.no
1	Importance of Communication & Information	99
2	General Qualities of Good Information	99
3	Monitoring Of Internal Controls	99
4	Inherent Limitations of Internal Controls	99
5	Difficulties in Maintaining Sound System of Internal Control in Outsourcing	99
6	Causes of Internal Control Failures	100
7	Contents of Report on Internal Control	100
8	Mandatory External Reporting of Internal Financial Controls & Risk	100

## *Exam Awareness*

## 1 Importance of Communication & Information

### 1.1 Upward Communication

### 1.2 Downward Communication

## 2 General Qualities of Good Information

- 1) Authoritative
- 2) Complete
- 3) Cost Beneficial
- 4) User Targeted
- 5) Reliable
- 6) Accurate
- 7) Timely
- 8) Easy To Use

## 3 Monitoring Of Internal Controls

## 4 Inherent Limitations of Internal Controls

- 1) Collusion Between Employees
- 2) Human Error
- 3) Lack Of Knowledge & Experience
- 4) Non Routine Transaction
- 5) Management Circumvention Of Control
- 6) Cost Benefit Considerations

## 5 Difficulties in Maintaining Sound System of Internal Control in Outsourcing

6 Causes of Internal Control Failures

7 Contents of Report on Internal Control

8 Mandatory External Reporting of Internal Financial Controls & Risk

8.1 Benefits

8.2 Limitations



Exam Topic 20:  
**AUDIT COMMITTEE AND INTERNAL  
AUDIT DEPARTMENT**

---

Sub Exam Topics

S.no	Headings (click the cross-ref below for easy navigation)	Pg.no
1	Roles of Audit Committee	102
2	Internal Audit Testing	102
3	Role of Internal Audit Function	102
4	Independence of Internal Audit Function	102
5	Assessing the Need for Internal Audit Function	102
6	Internal Audit in Public Companies	102
7	Outside vs. In-House Appointment of Internal Auditor (Also Applicable For Risk Manager)	102
8	Internal Vs. External Auditor	102
9	Objectives of Internal Audit	102

Designed by: [accasupport.com](http://accasupport.com)

*Exam Awareness*

- 1 Roles of Audit Committee
- 2 Internal Audit Testing
- 3 Role of Internal Audit Function
- 4 Independence of Internal Audit Function
- 5 Assessing the Need for Internal Audit Function
- 6 Internal Audit in Public Companies
- 7 Outside vs. In-House Appointment of Internal Auditor (Also Applicable For Risk Manager)
- 8 Internal Vs. External Auditor
- 9 Objectives of Internal Audit

Exam Topic 21:

# ROLES OF RISK MANAGEMENT COMMITTEE & DEPARTMENT

---

Sub Exam Topics

S.no	Headings (click the cross-ref below for easy navigation)	Pg.no
1	Roles of Risk Management Committee	104
2	Composition of Risk Management Committee	104
3	Benefits of Risk Management Committee	104
4	Benefits of Non-Executive Risk Committee	104
5	Role of Risk Manager or Risk Management Department	104
6	Outsourcing Risk Management	104
7	Benefits of Outsourcing Risk Management	104

*Exam Awareness*

- 1 Roles of Risk Management Committee
- 2 Composition of Risk Management Committee
- 3 Benefits of Risk Management Committee
- 4 Benefits of Non-Executive Risk Committee
- 5 Role of Risk Manager or Risk Management Department
- 6 Outsourcing Risk Management
- 7 Benefits of Outsourcing Risk Management

## RELATED PRODUCTS

---

Books	Free Demo
<b>Management Accounting</b>	<b><u><a href="#">F2</a></u></b>
<b>Performance Management</b>	<b><u><a href="#">F5</a></u></b>
<b>Financial Management</b>	<b><u><a href="#">F9</a></u></b>
<b>Governance, Risk &amp; Ethics</b>	<b><u><a href="#">P1</a></u></b>
<b>Business Analysis</b>	<b><u><a href="#">P3</a></u></b>
<b>Ebusiness/Ecommerce/Make Money Online</b>	<b><u><a href="#">\$£€</a></u></b>

Click the hyperlinks above in underlined style to visit relevant webpage at <http://accasupport.com>

## FREE BLOGS

---

<http://accasupport.com/blogs.htm>

<http://businessanalysis.accasupport.com>

<http://riskmanagement.accasupport.com>

<http://financialmanagement.accasupport.com/>

<http://managementaccounting.accasupport.com/>

<http://accalecturenotes.blogspot.com>

Free blogs contain many of the exam topics, which are also popular in practice. These blogs only contain essential technical and theoretical knowledge applicable to accounting & finance professional qualifications; business management, marketing and businesses (Sole proprietors, partnerships, companies) in general.

It does not contain exam-focused articles and topic related exam awareness and exam support; examples, diagrams, tables, illustrations, explanations, highlighting etc due to difficulties involved in formatting articles posted on blogs.

# REPORT ABUSE

---

Please inform me at [kabuli\\_52@hotmail.com](mailto:kabuli_52@hotmail.com) (preferred) or [murtaza@accasupport.com](mailto:murtaza@accasupport.com), if you find any misuse of this study material or [www.accasupport.com](http://www.accasupport.com). In addition, if you find any information in this study material or website that is awkward, unethical, other than normal etc from your viewpoint.

This study material is not available at any other website over the internet except clickbank.com. In addition, this study material is not available in the form of printed books, DVDs etc.

Website hacking is very common over the internet. Hackers modify, delete and add contents on the targeted websites by gaining unauthorized access to webserver, where the webpages are stored.

Reporting abuse will save other visitors to the website from being victimized. Please help me discouraging these anti-social elements.

I will keep confidential any corresponding between us.

For more info, please see my [privacy policy](#)